

# NYWA Regional (Byron)

**PreK & K  
40 lbs**

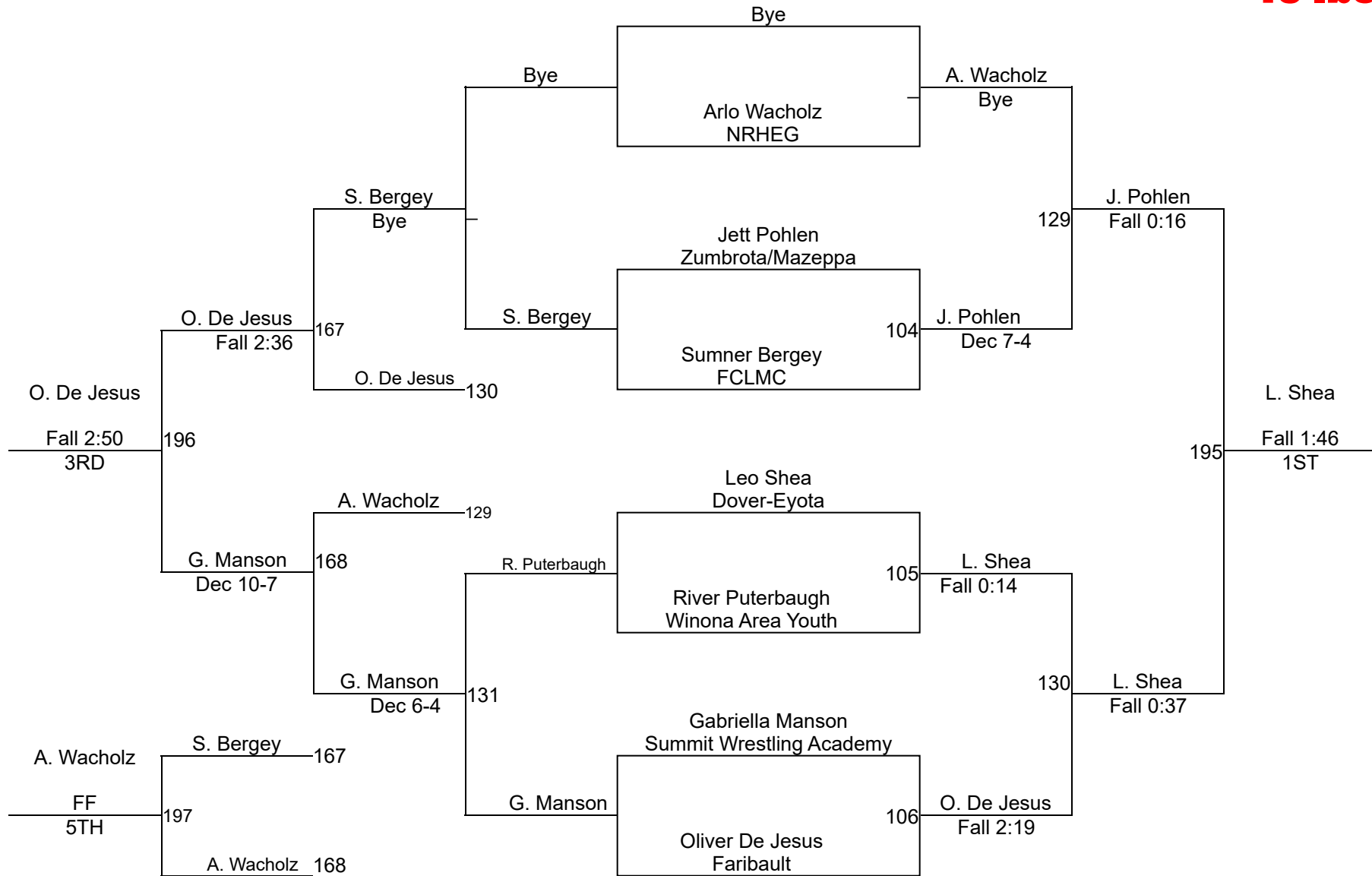

# NYWA Regional (Byron)

**PreK & K 45**

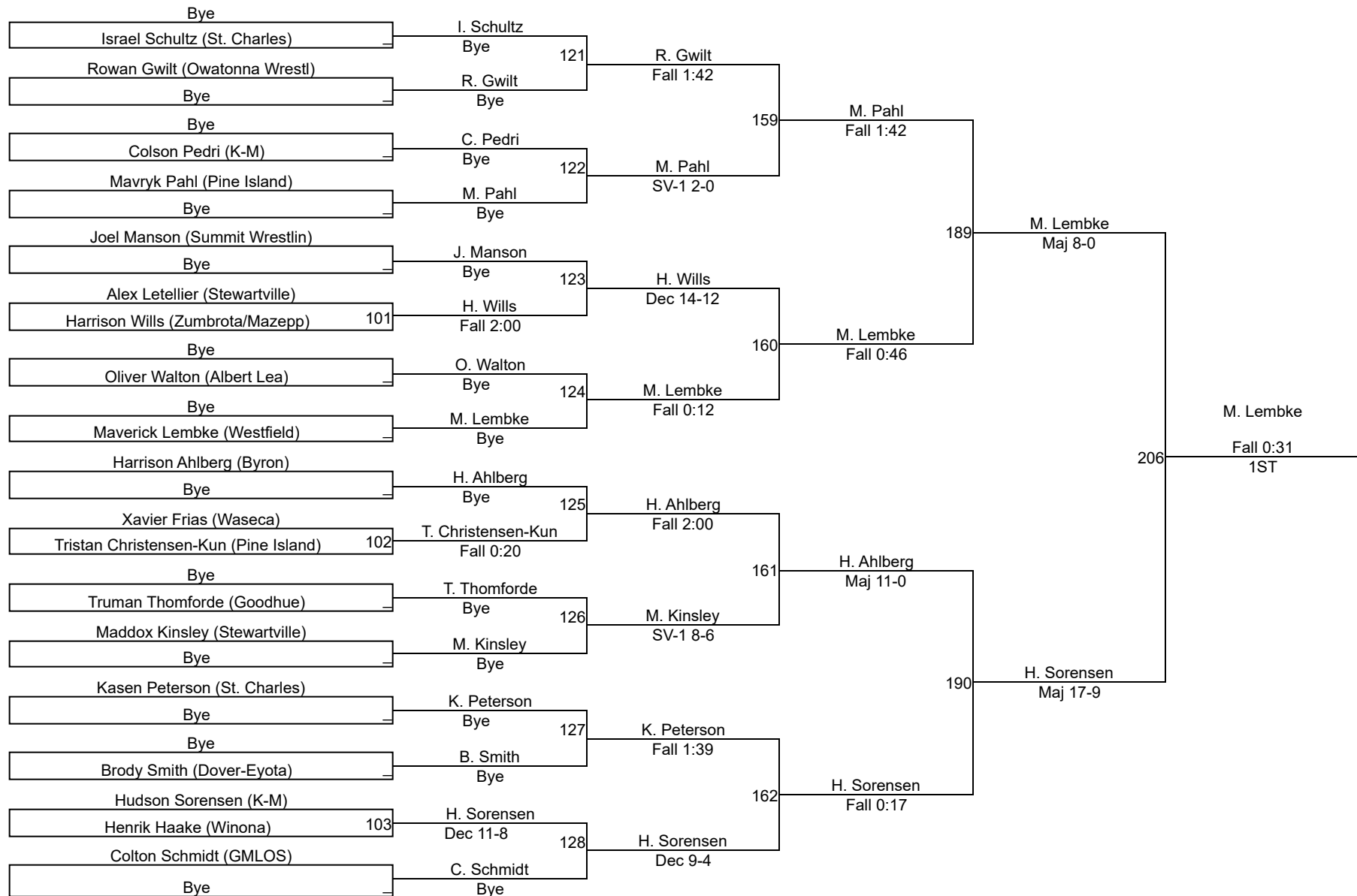

# PreK & K 45

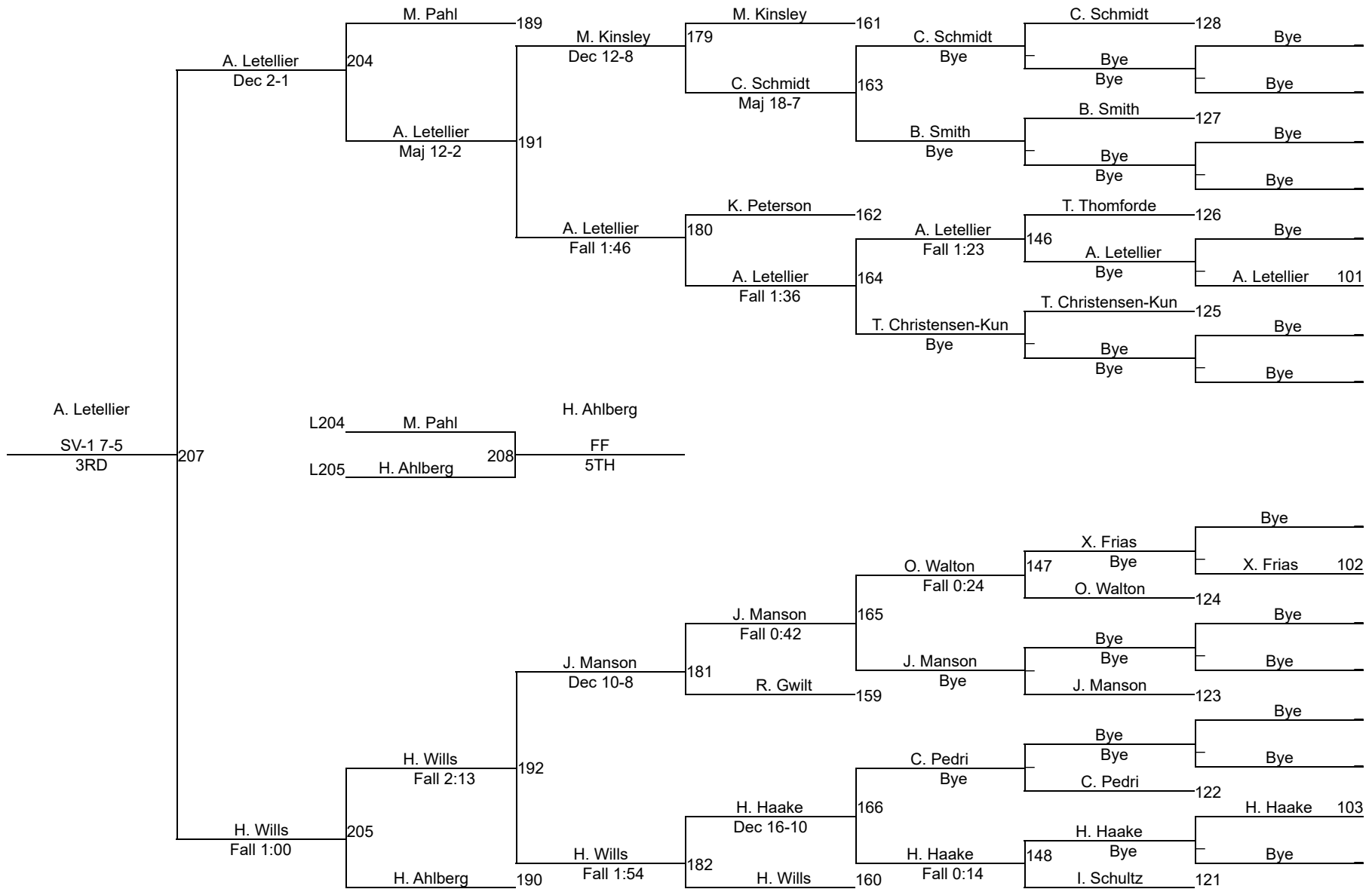

# NYWA Regional (Byron)

**PreK & K  
50 lbs**

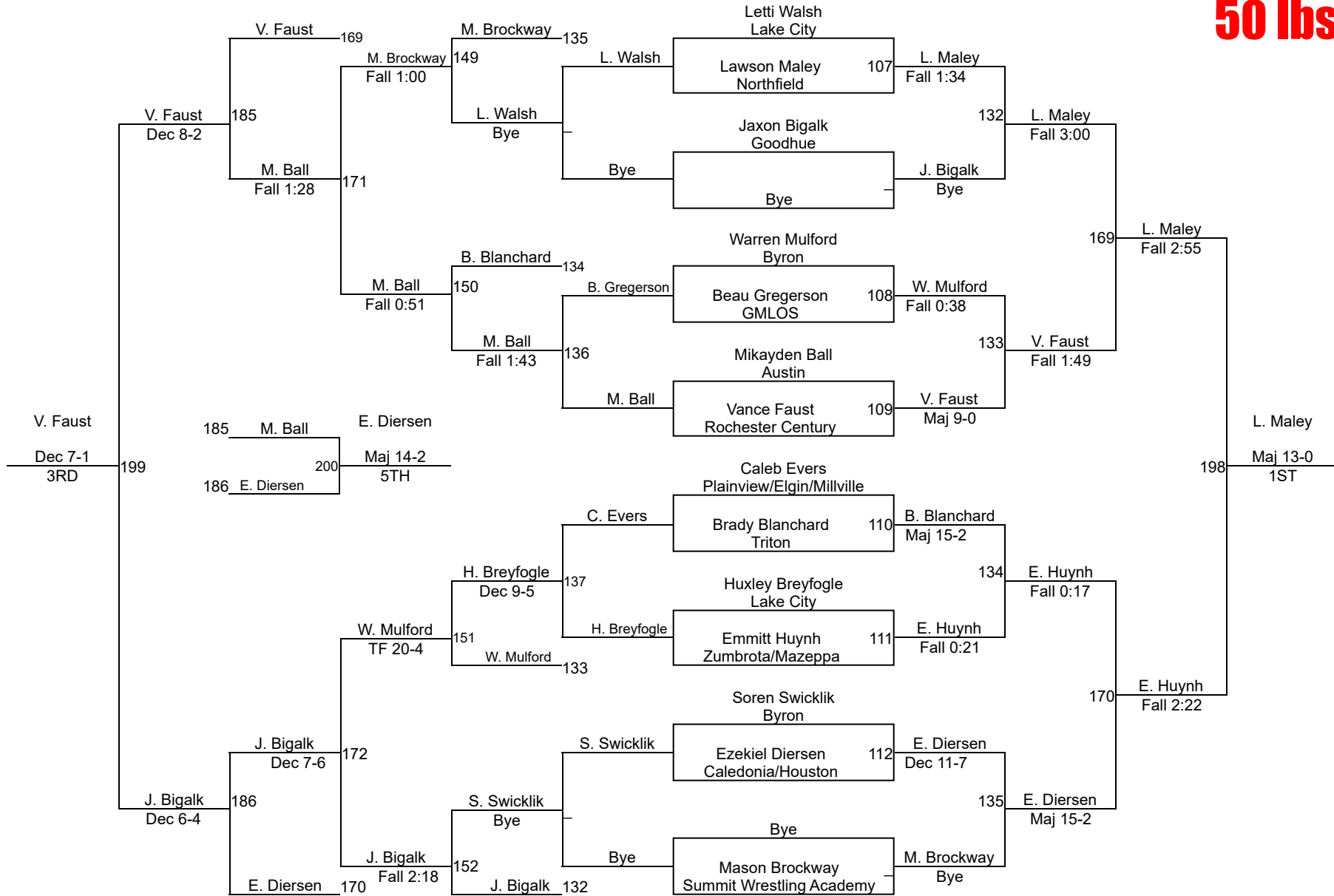

# NYWA Regional (Byron)

**PreK & K**  
**55 lbs**

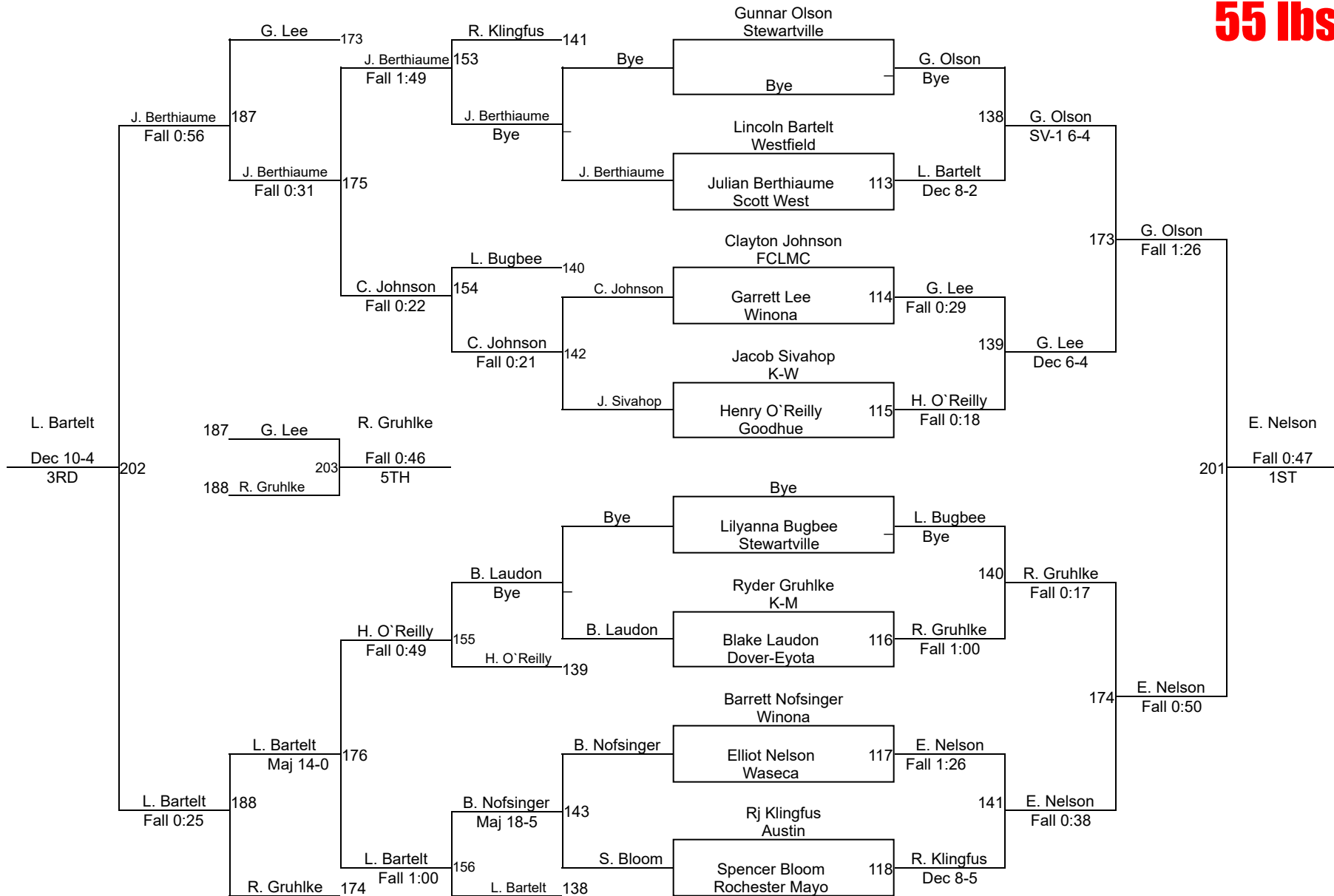

# NYWA Regional (Byron)

# PreK & K 60

Bye	Z. Ranvek
Z. Ranvek	Bye

Bye	C. Bartsch
C. Bartsch	Bye

Bye	V. Seckerson
V. Seckerson	Bye

Bye	K. Franko
K. Franko	Bye

Bye	R. Boldt
R. Boldt	Bye

## Round 1

R. Boldt	K. Franko
K. Franko 119	Maj 15-1

## Round 2

R. Boldt	V. Seckerson
V. Seckerson 144	Dec 10-4

## Round 3

R. Boldt	Z. Ranvek
Z. Ranvek 157	Fall 2:33

## Round 4

R. Boldt	R. Boldt
C. Bartsch 183	Fall 2:58

## Round 5

K. Franko	K. Franko
V. Seckerson 193	Maj 11-0

V. Seckerson	V. Seckerson
C. Bartsch 120	Fall 0:57

K. Franko	Z. Ranvek
Z. Ranvek 145	Dec 8-4

K. Franko	K. Franko
C. Bartsch 158	Dec 8-7

V. Seckerson	Z. Ranvek
Z. Ranvek 184	Fall 1:43

C. Bartsch	Z. Ranvek
Z. Ranvek 194	Fall 0:55

Zayne Ranvek (K-M)

**1ST**

Keenyn Franko (Byron)

**2ND**

Veda Seckerson (Chatfield)

**3RD**

Remington Boldt (Caledonia/Houston)

**4TH**

Colson Bartsch (NRHEG)

**5TH**

Bye

**6TH**

# NYWA Regional (Byron)

**PreK & K**  
**70 lbs**

Round 1

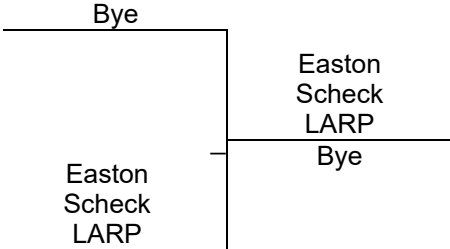

Round 2

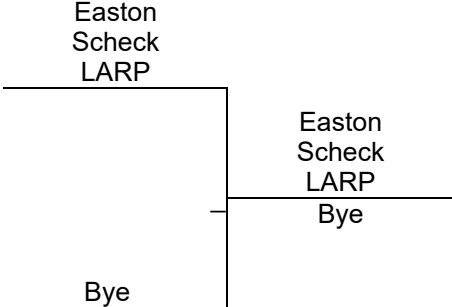

Round 3

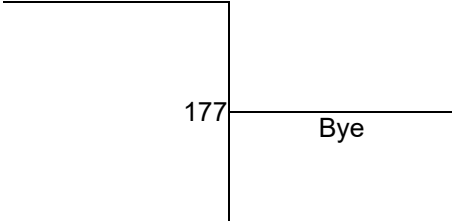

E. Scheck (LARP)  
**1ST**

Bye  
**2ND**

# NYWA Regional (Byron)

**PreK & K**  
**105 lbs**

Round 1

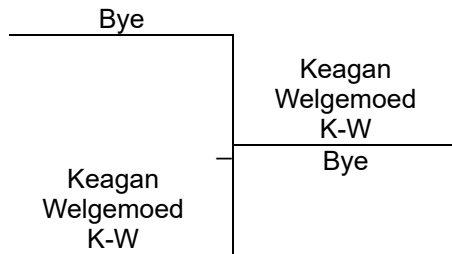

Round 2

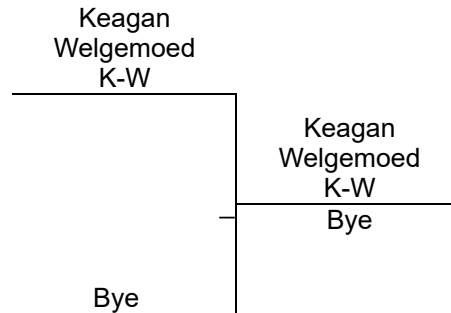

Round 3

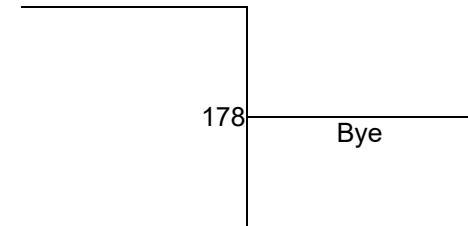

K. Welgemoed (K-W)

**1ST**

Bye

**2ND**



# NYWA Regional (Byron)

**1st & 2nd**  
**45 lbs**

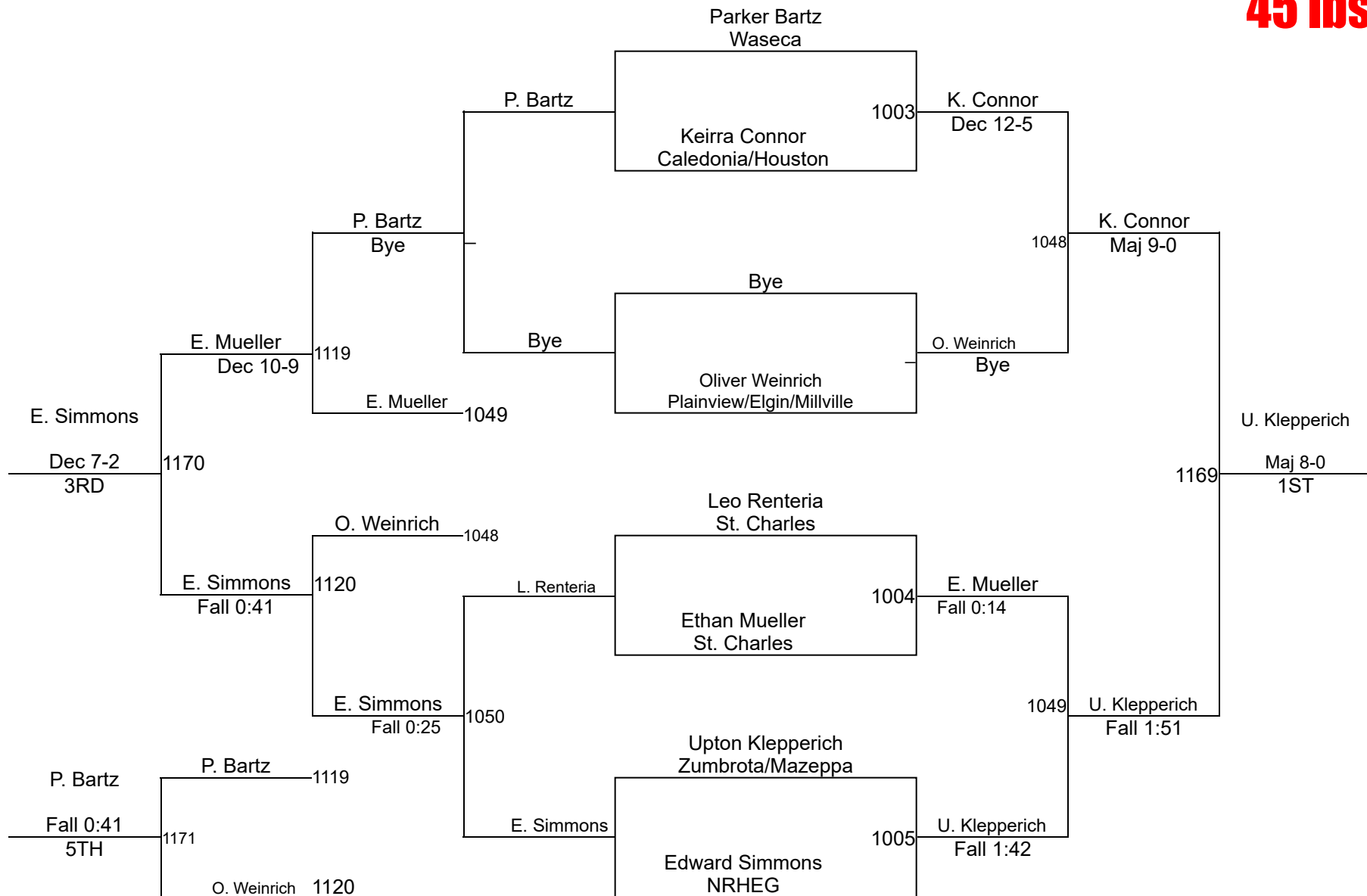

# NYWA Regional (Byron)

**1st & 2nd  
50 lbs**

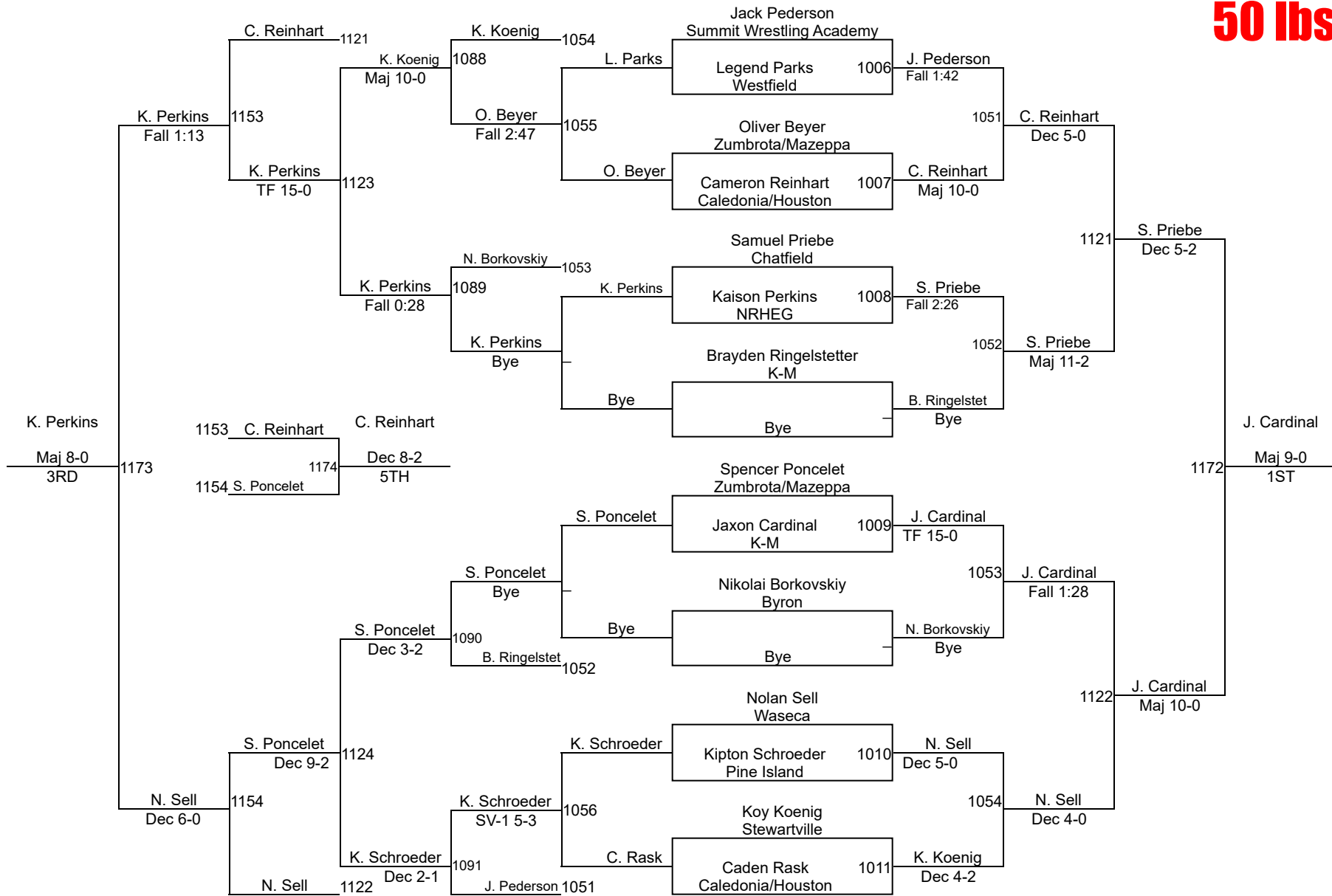

# NYWA Regional (Byron)

**1st & 2nd**  
**54 lbs**

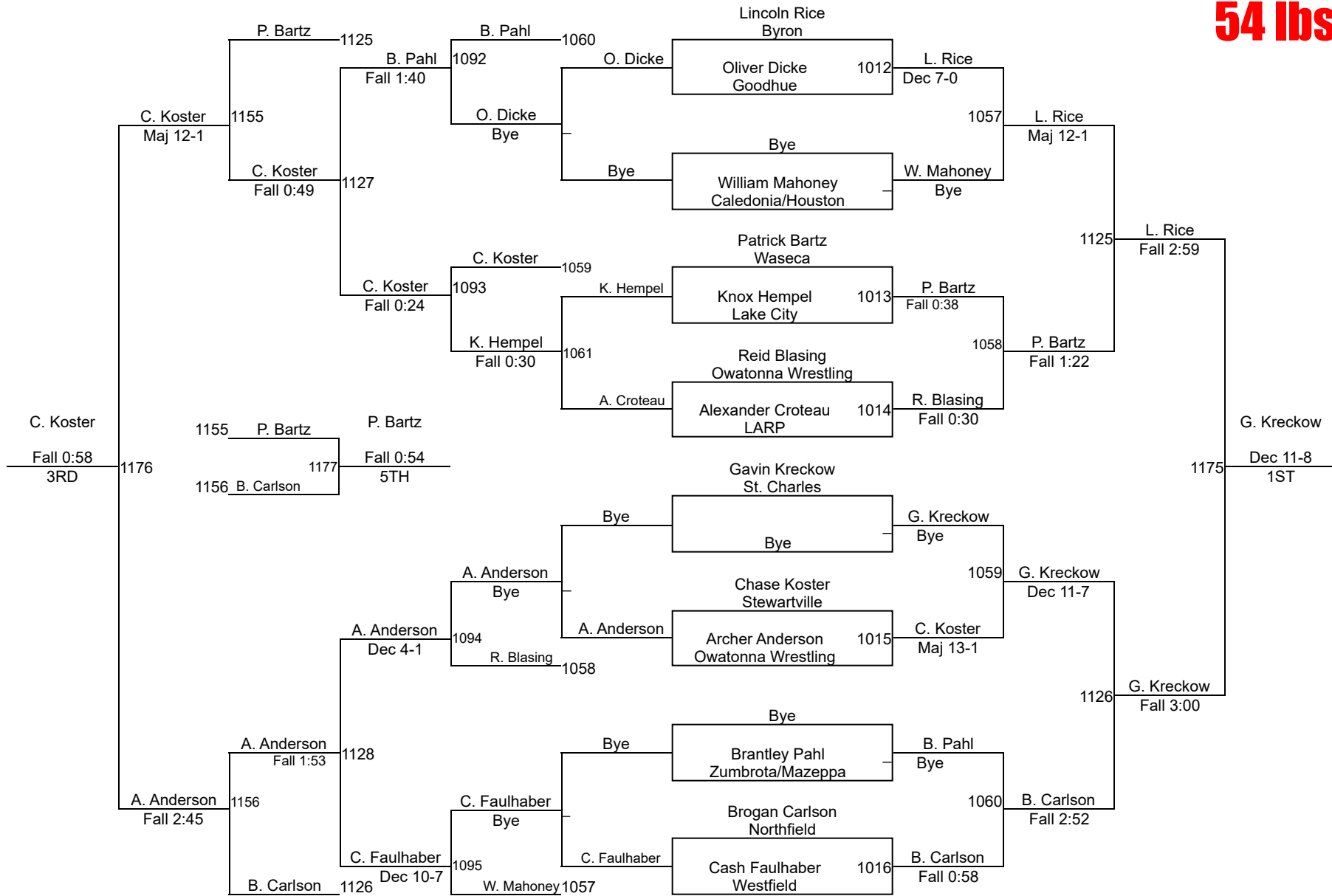

# NYWA Regional (Byron)

**1st & 2nd 57**

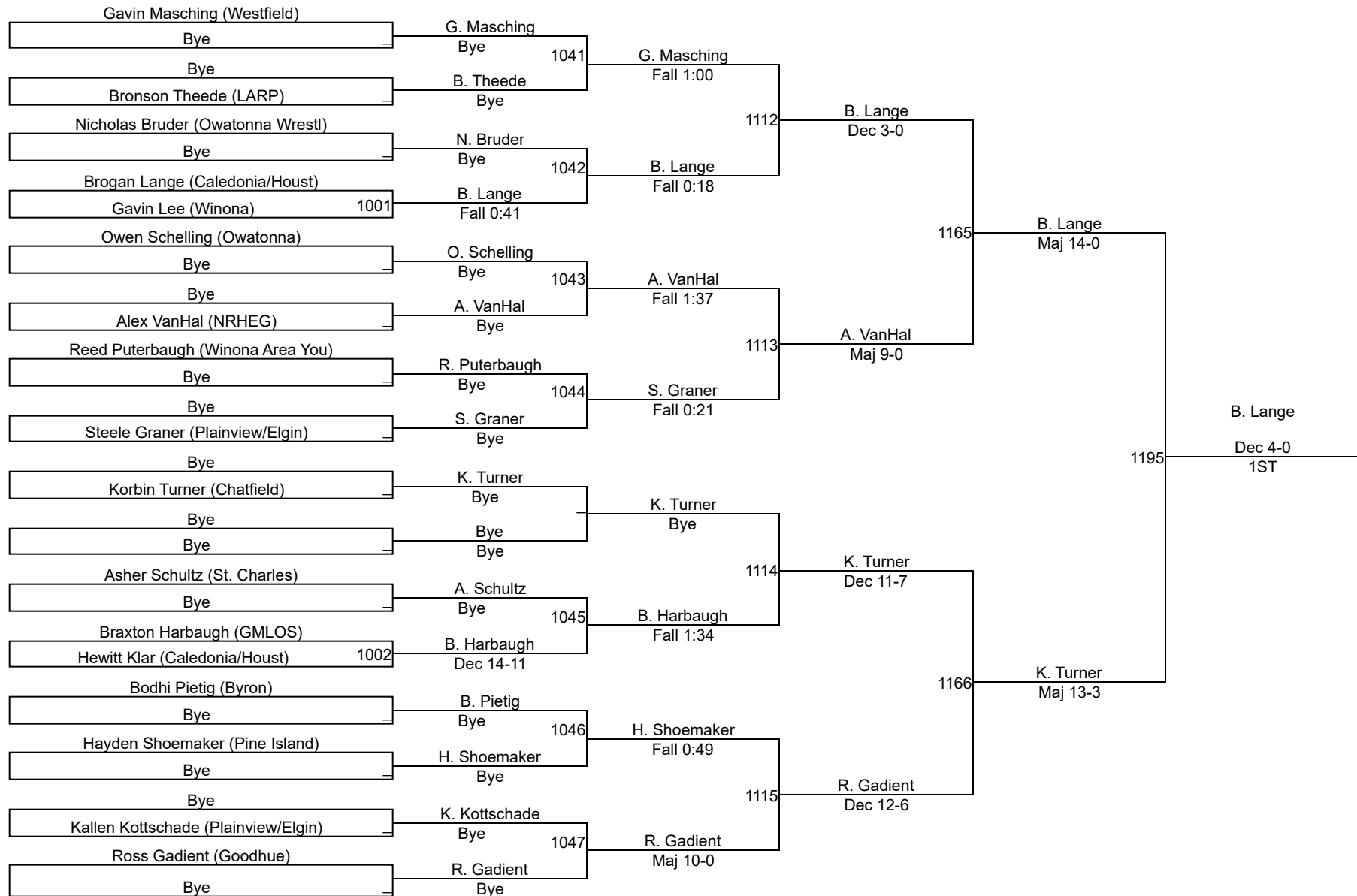

# 1st & 2nd 57

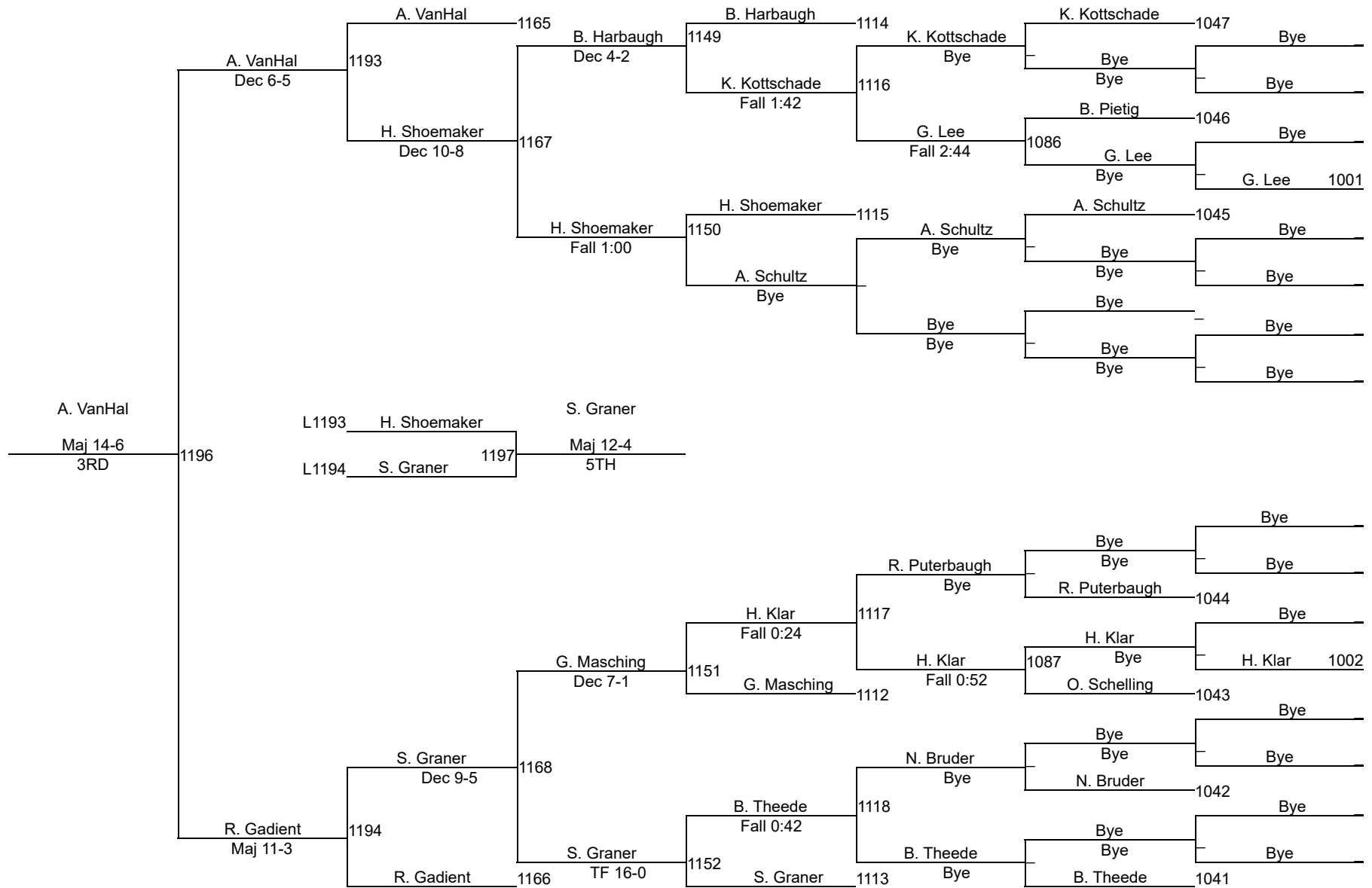

# NYWA Regional (Byron)

**1st & 2nd  
61 lbs**

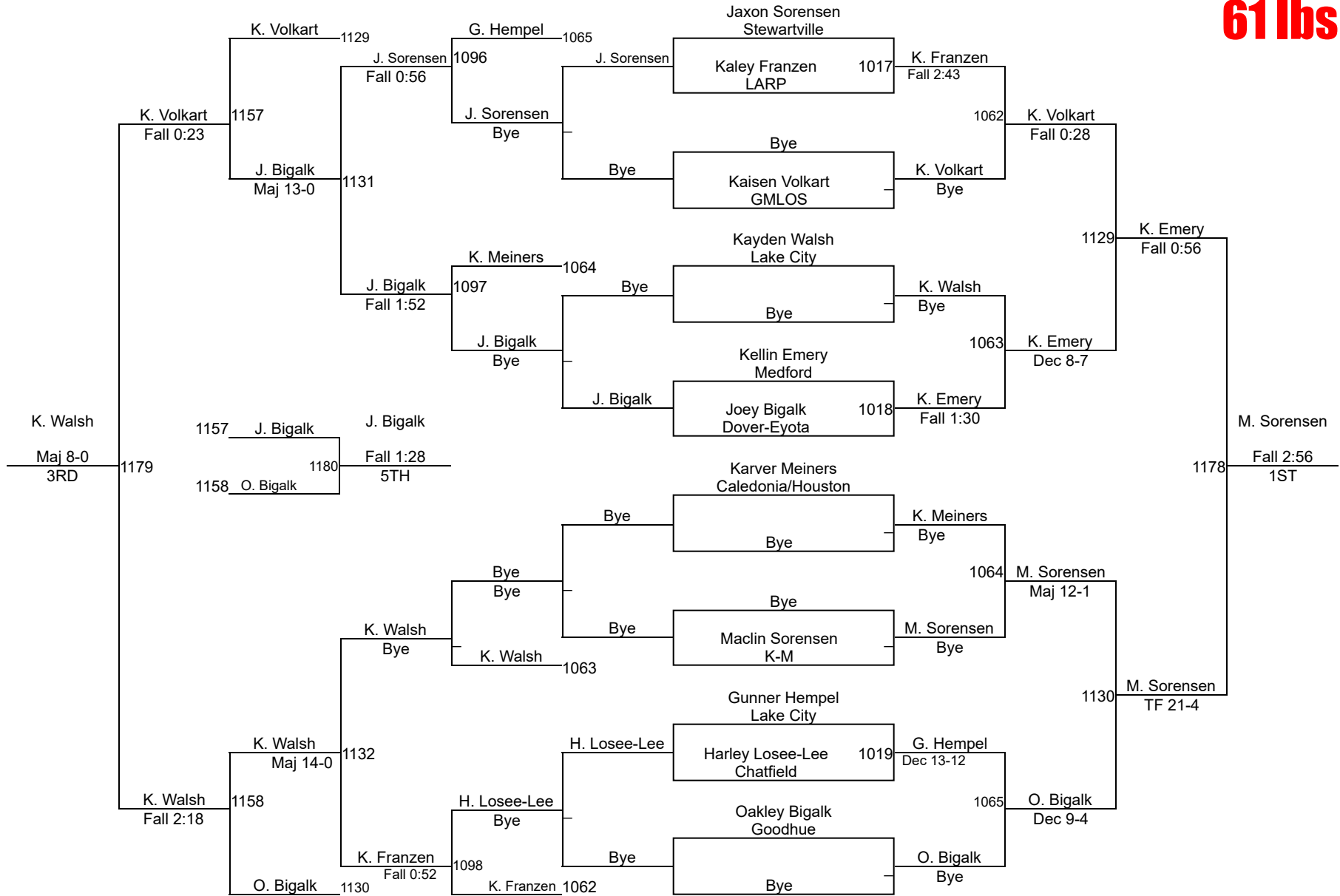

# NYWA Regional (Byron)

**1st & 2nd  
65 lbs**

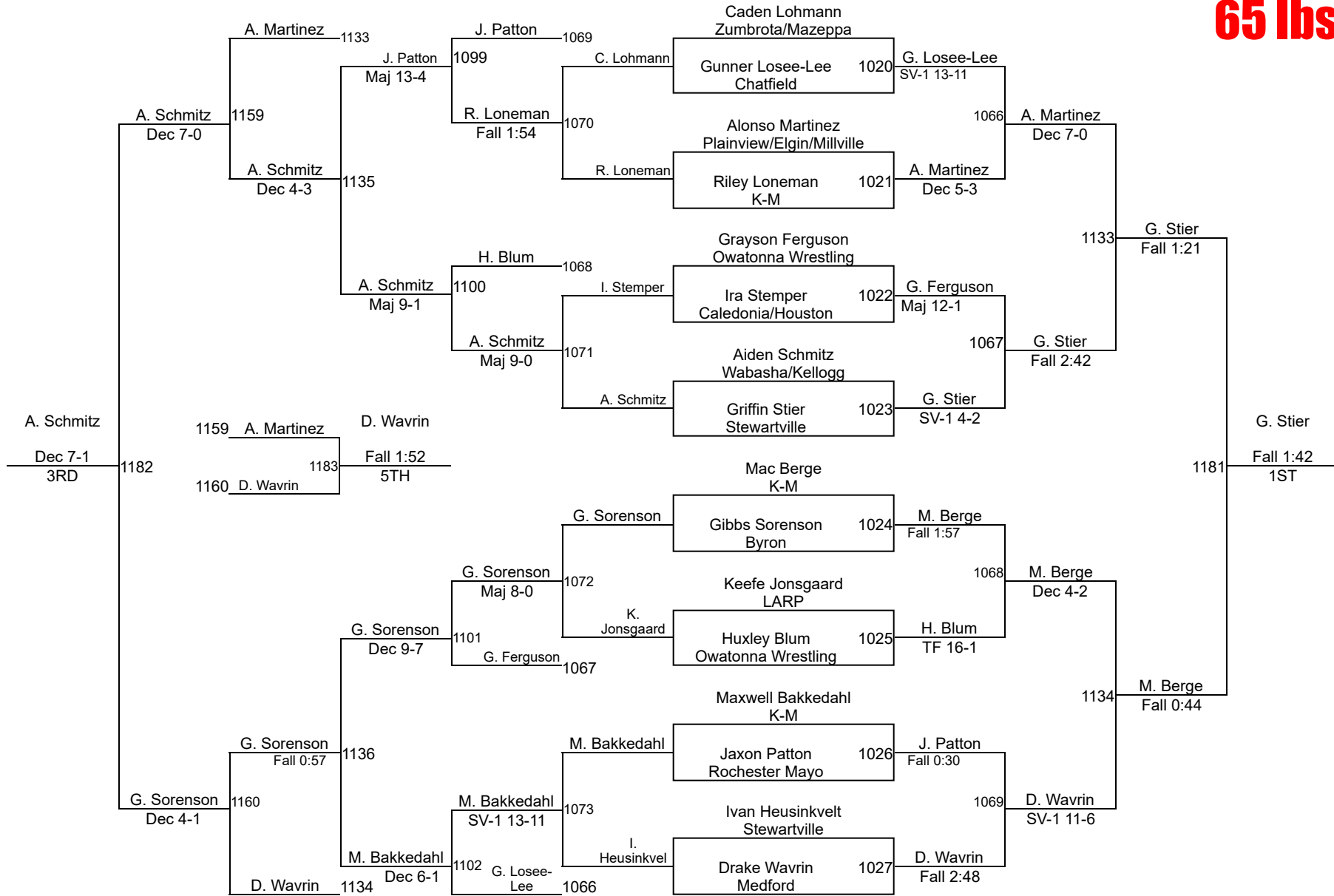

# NYWA Regional (Byron)

**1st & 2nd  
70 lbs**

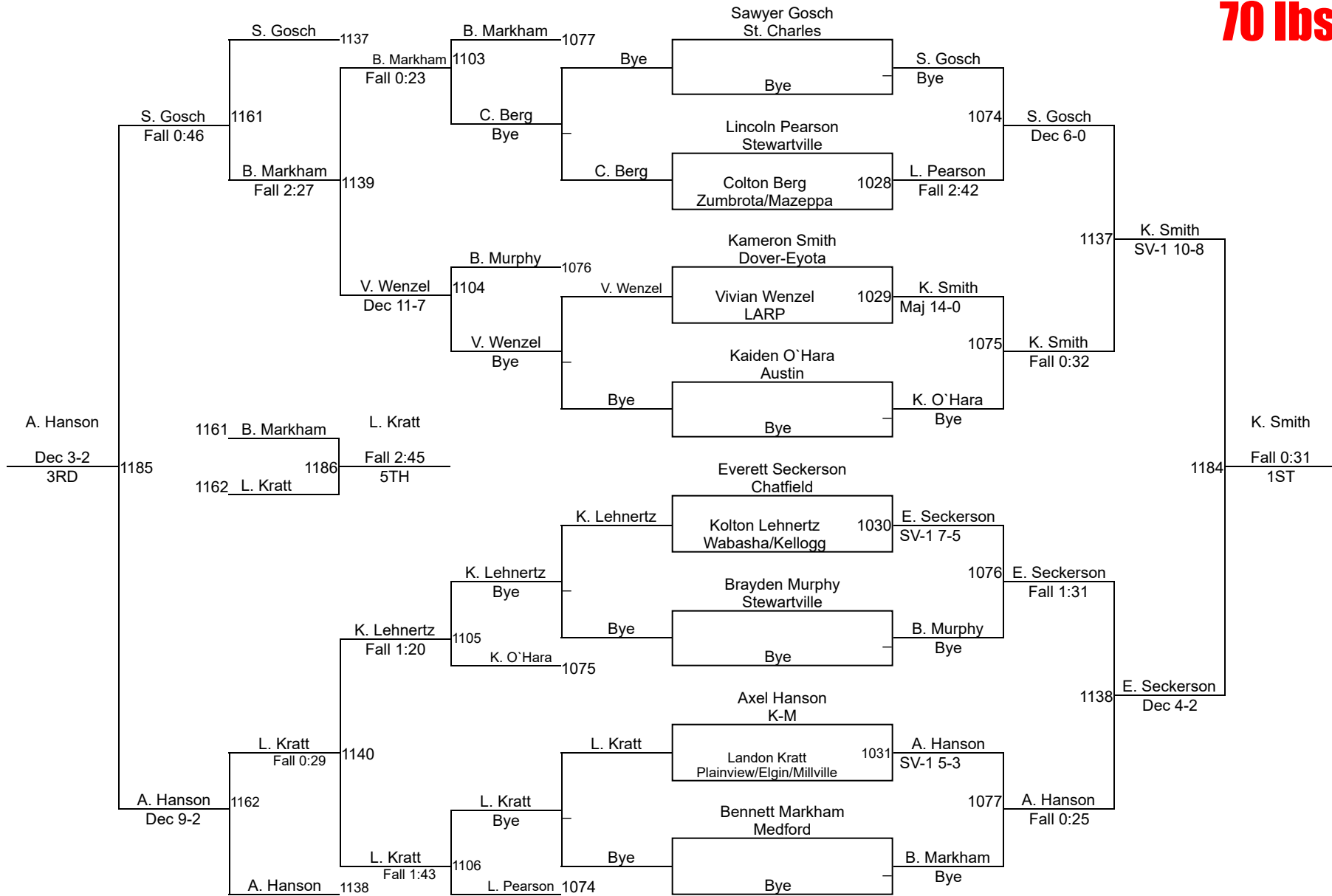



# NYWA Regional (Byron)

**1st & 2nd  
75 lbs**

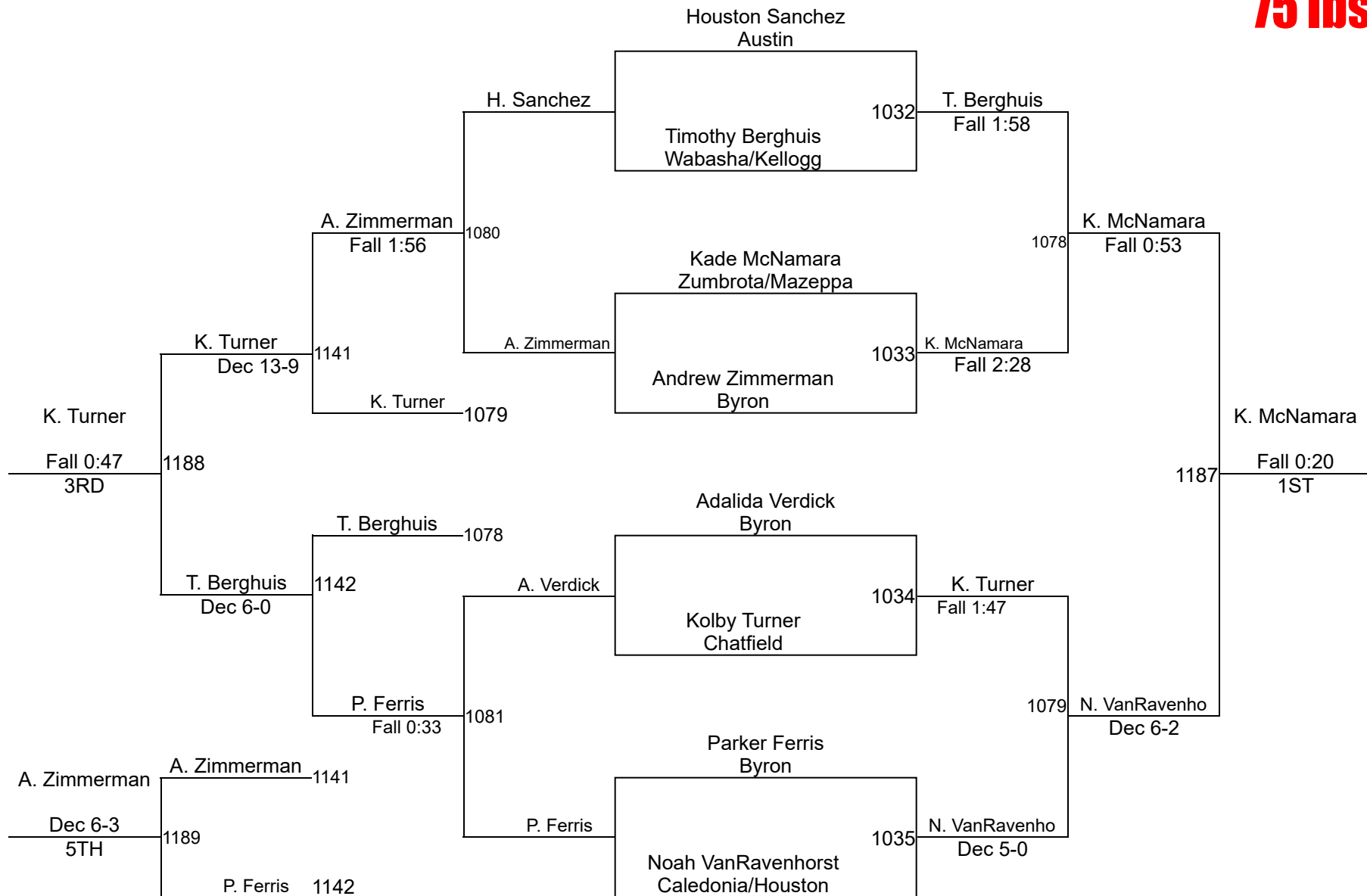

# NYWA Regional (Byron)

**1st & 2nd  
80 lbs**

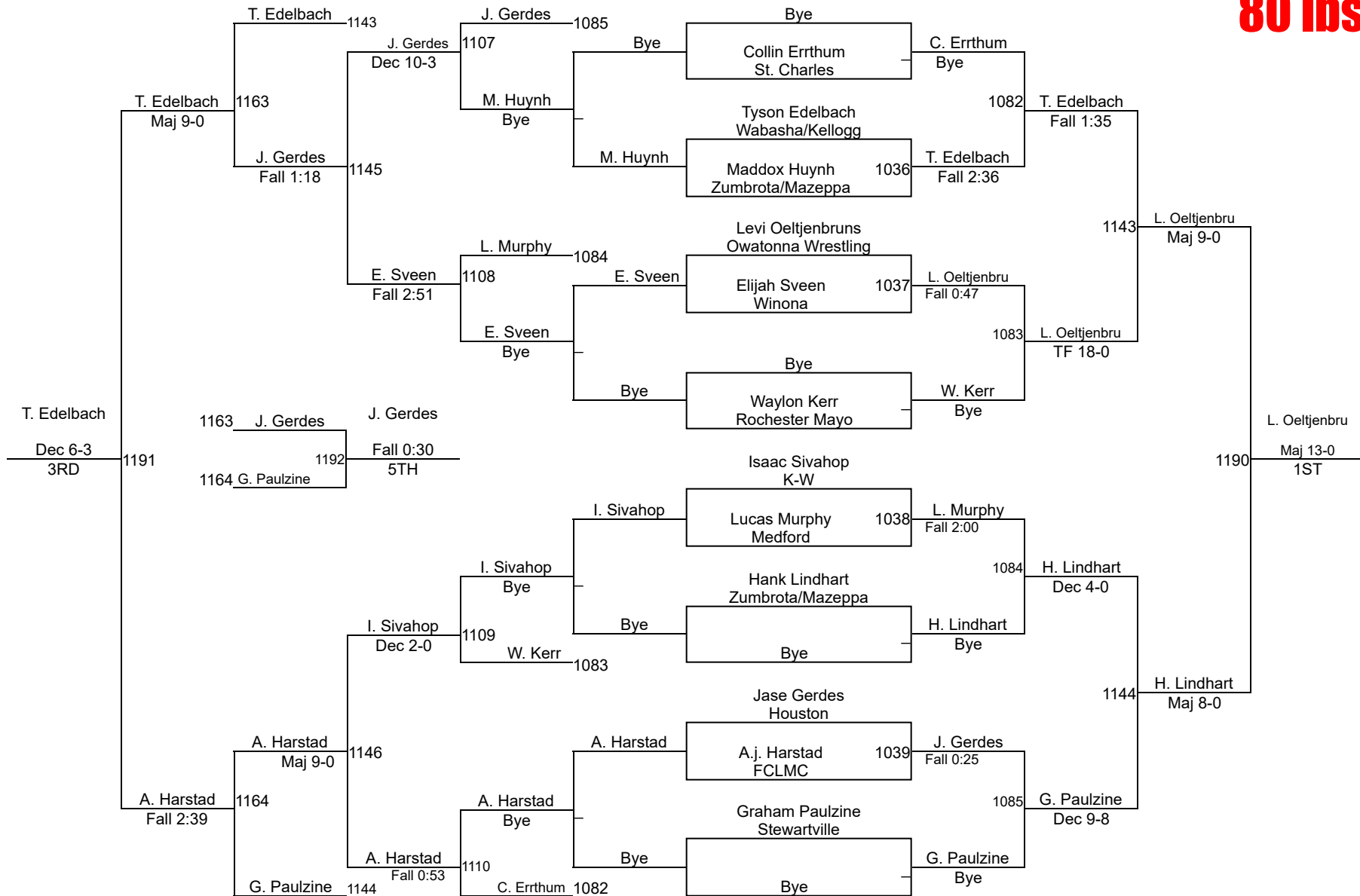

# NYWA Regional (Byron)

**1st & 2nd  
90 lbs**

Round 1

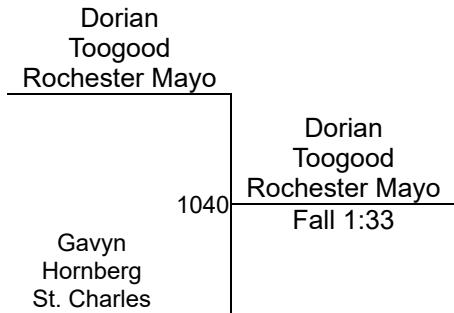

Round 2

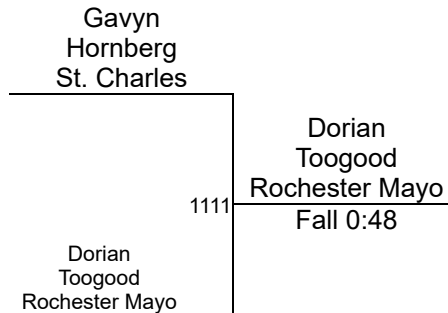

Round 3

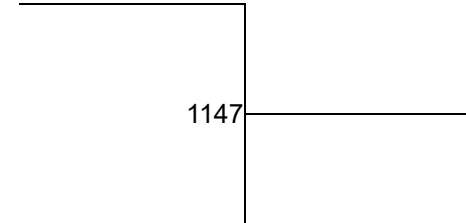

D. Toogood (Rochester Mayo)  
**1ST**

G. Hornberg (St. Charles)  
**2ND**



# NYWA Regional (Byron)

**3rd & 4th  
55 lbs**

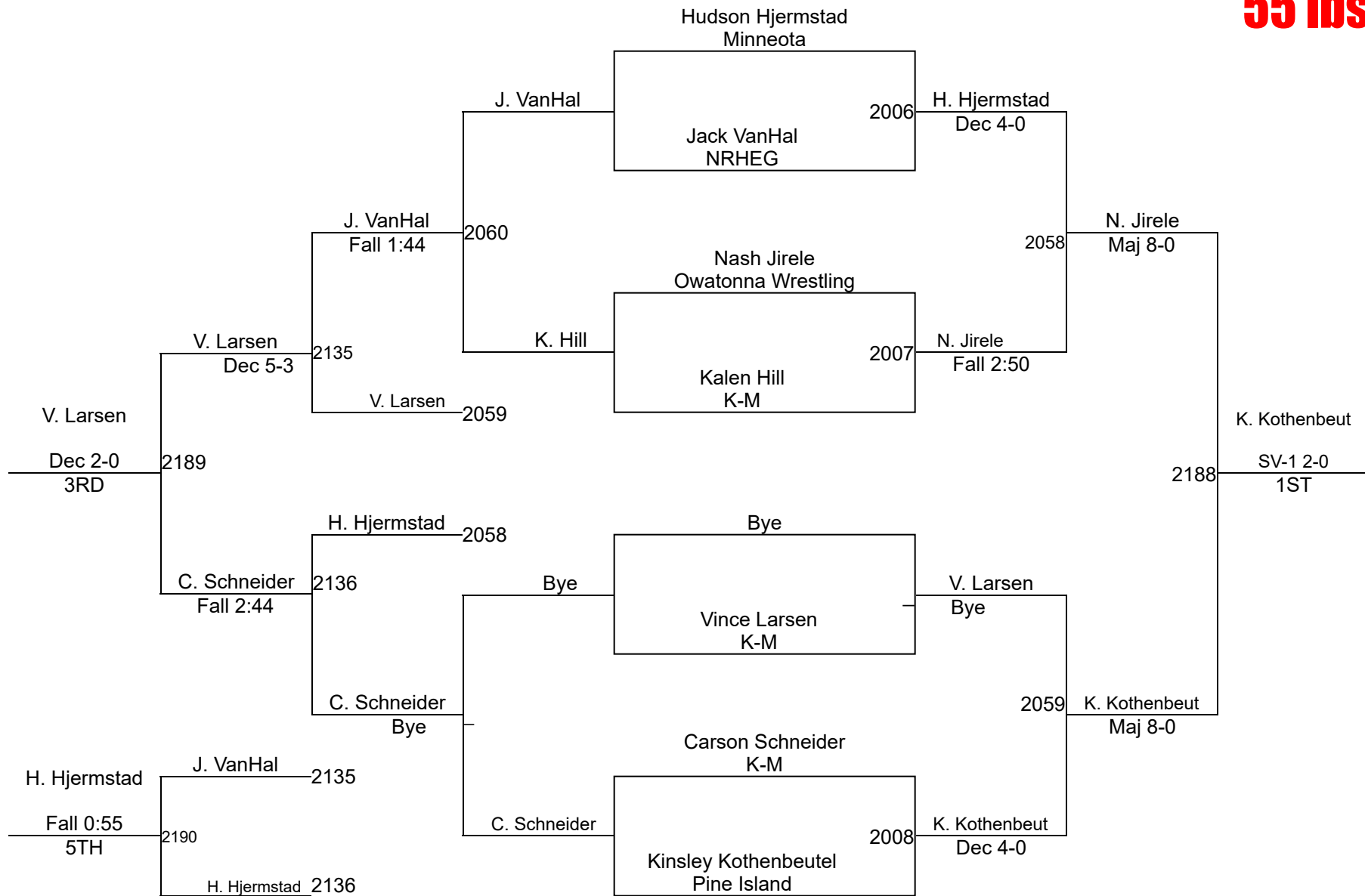

# NYWA Regional (Byron)

**3rd & 4th  
60 lbs**

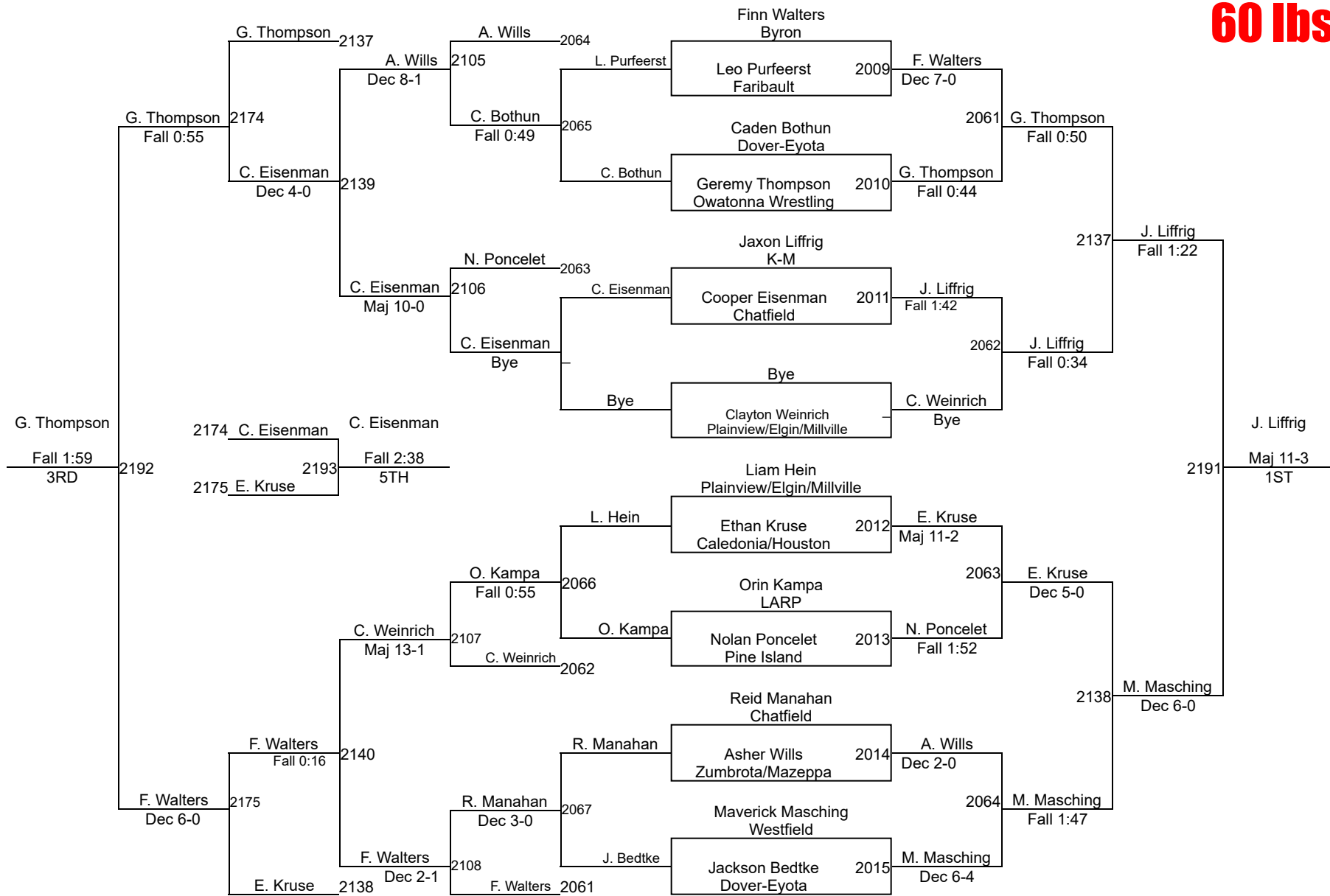

# NYWA Regional (Byron)

## 3rd & 4th 64

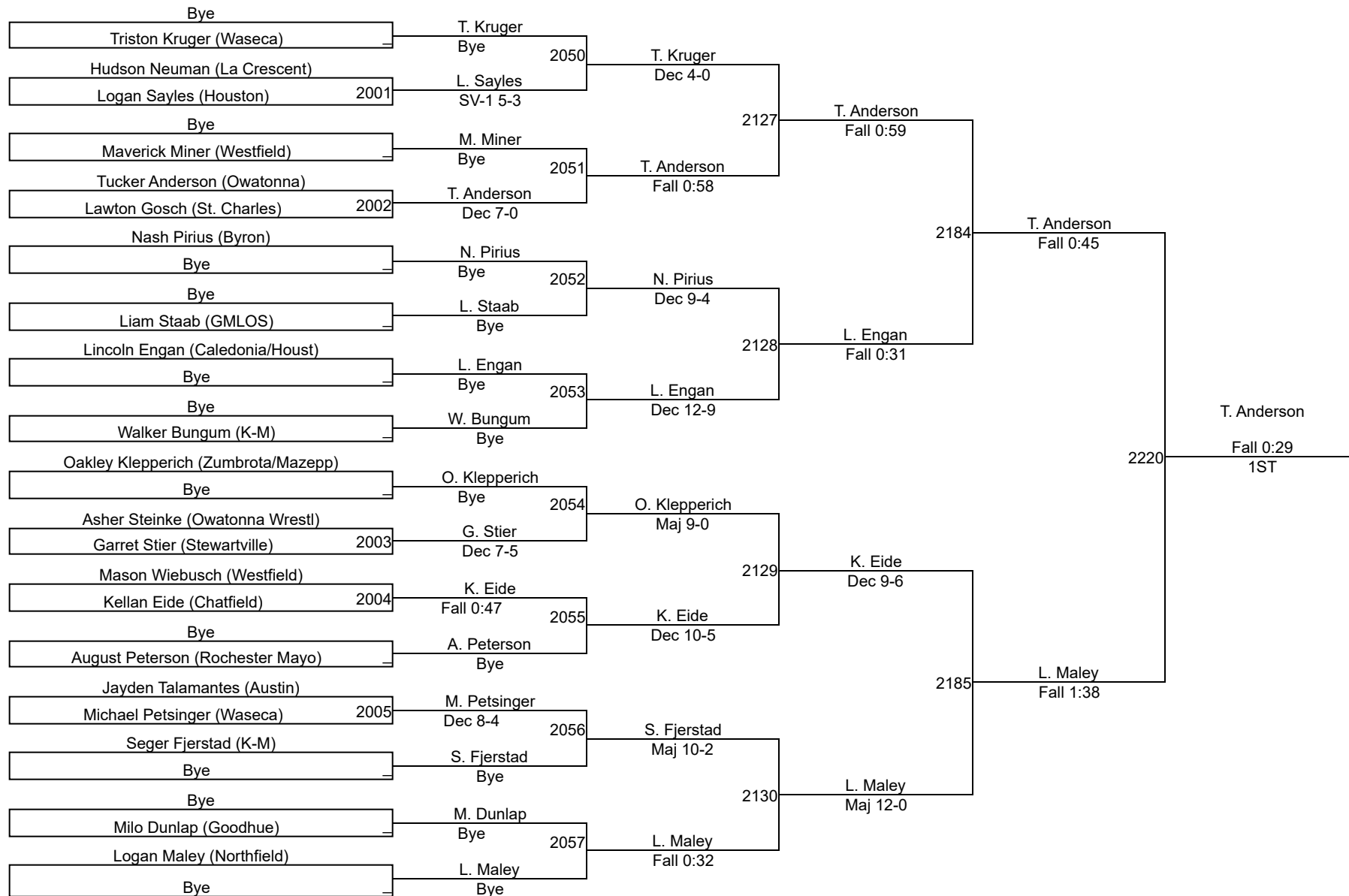

# 3rd & 4th 64

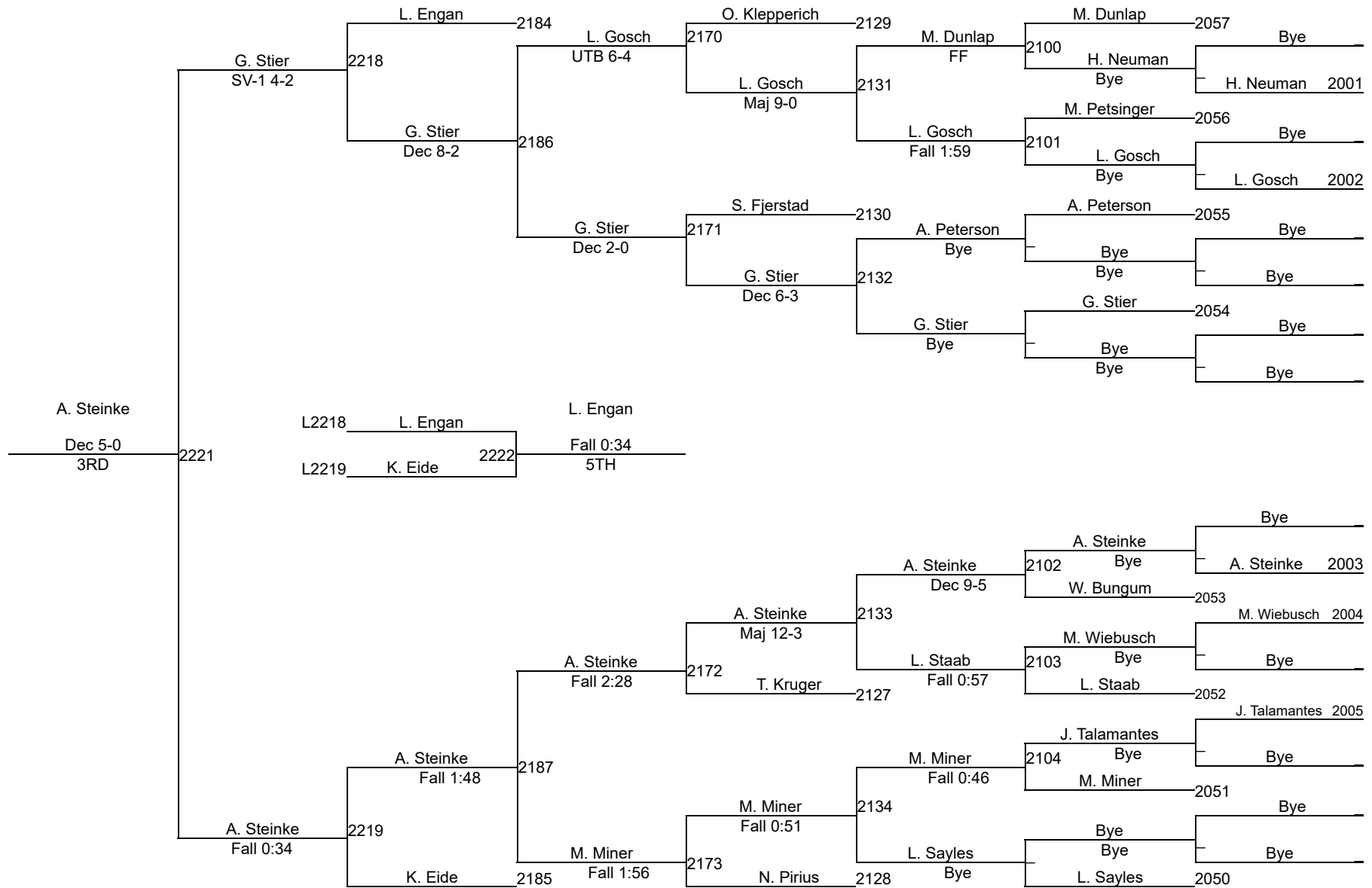





# NYWA Regional (Byron)

**3rd & 4th**  
**72 lbs**

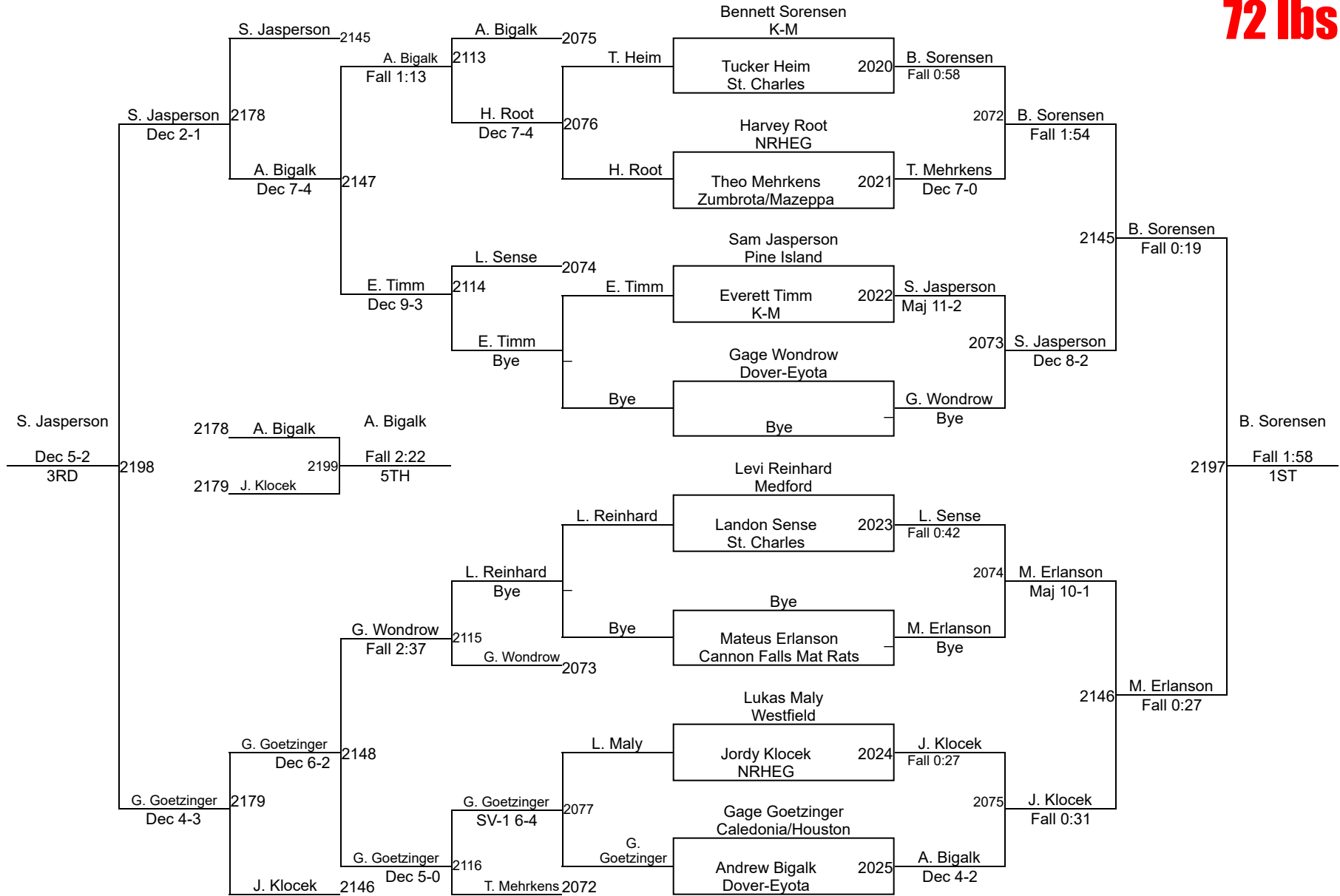

# NYWA Regional (Byron)

**3rd & 4th**  
**76 lbs**

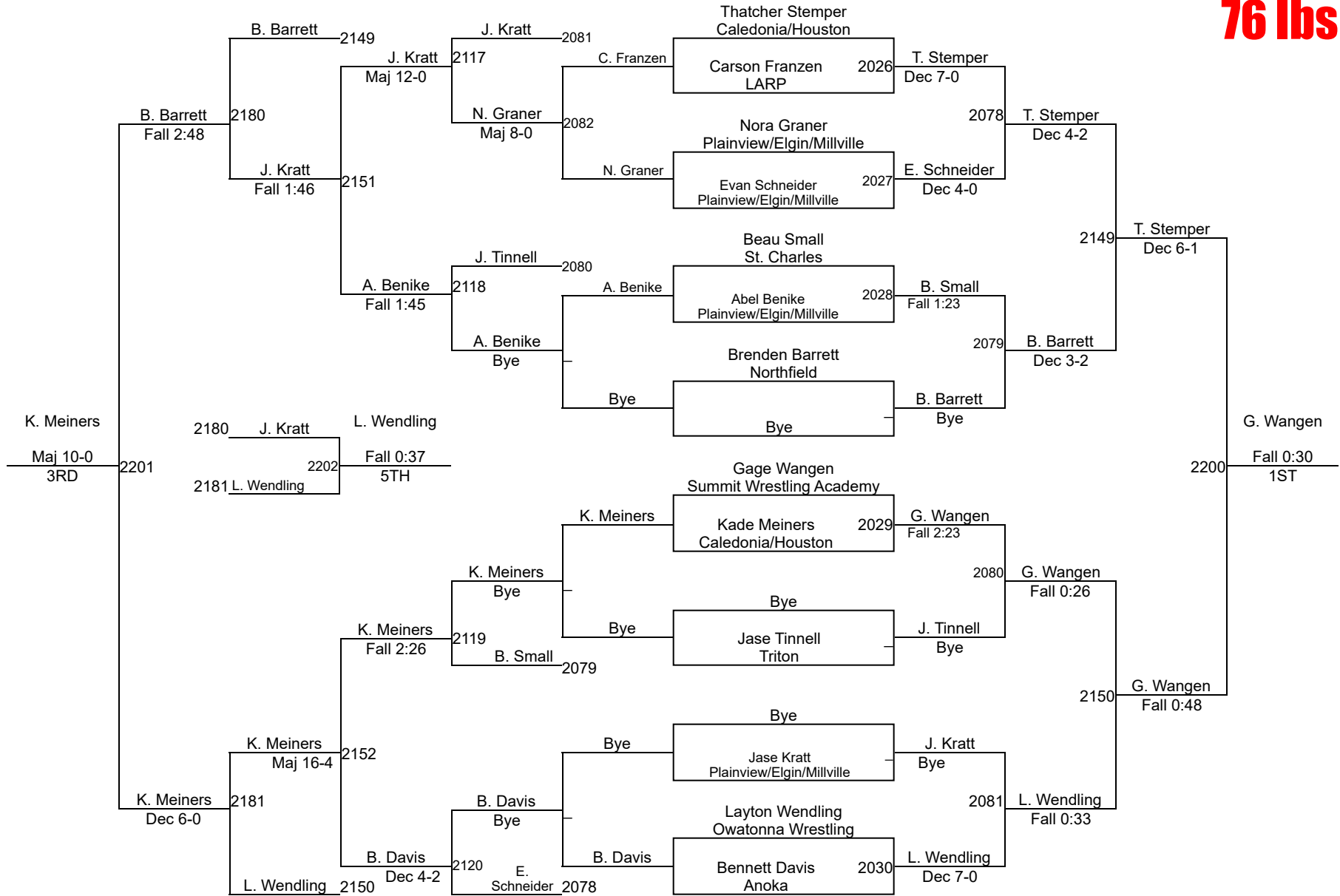

# NYWA Regional (Byron)

**3rd & 4th  
80 lbs**

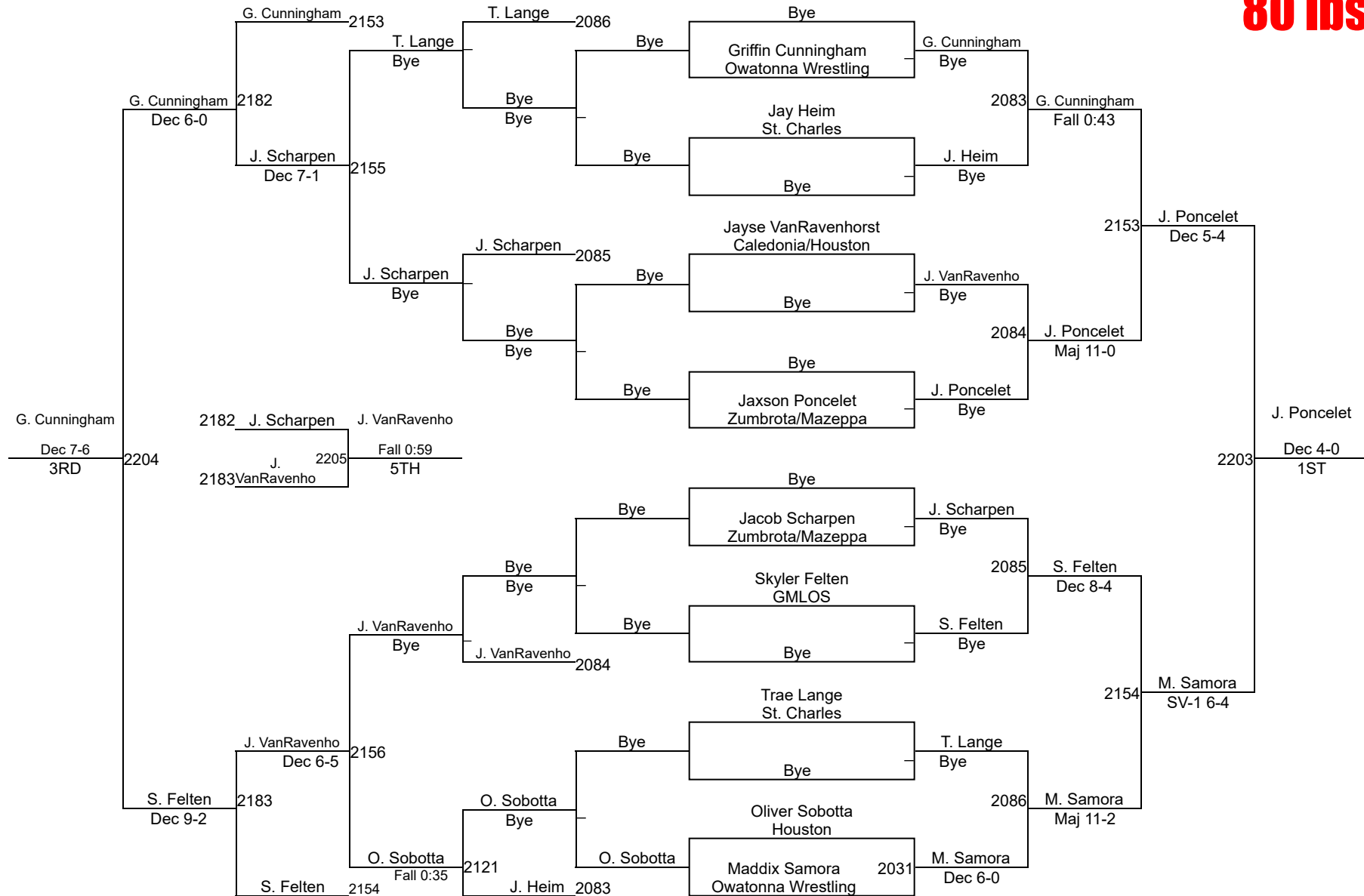

# NYWA Regional (Byron)

**3rd & 4th**  
**85 lbs**

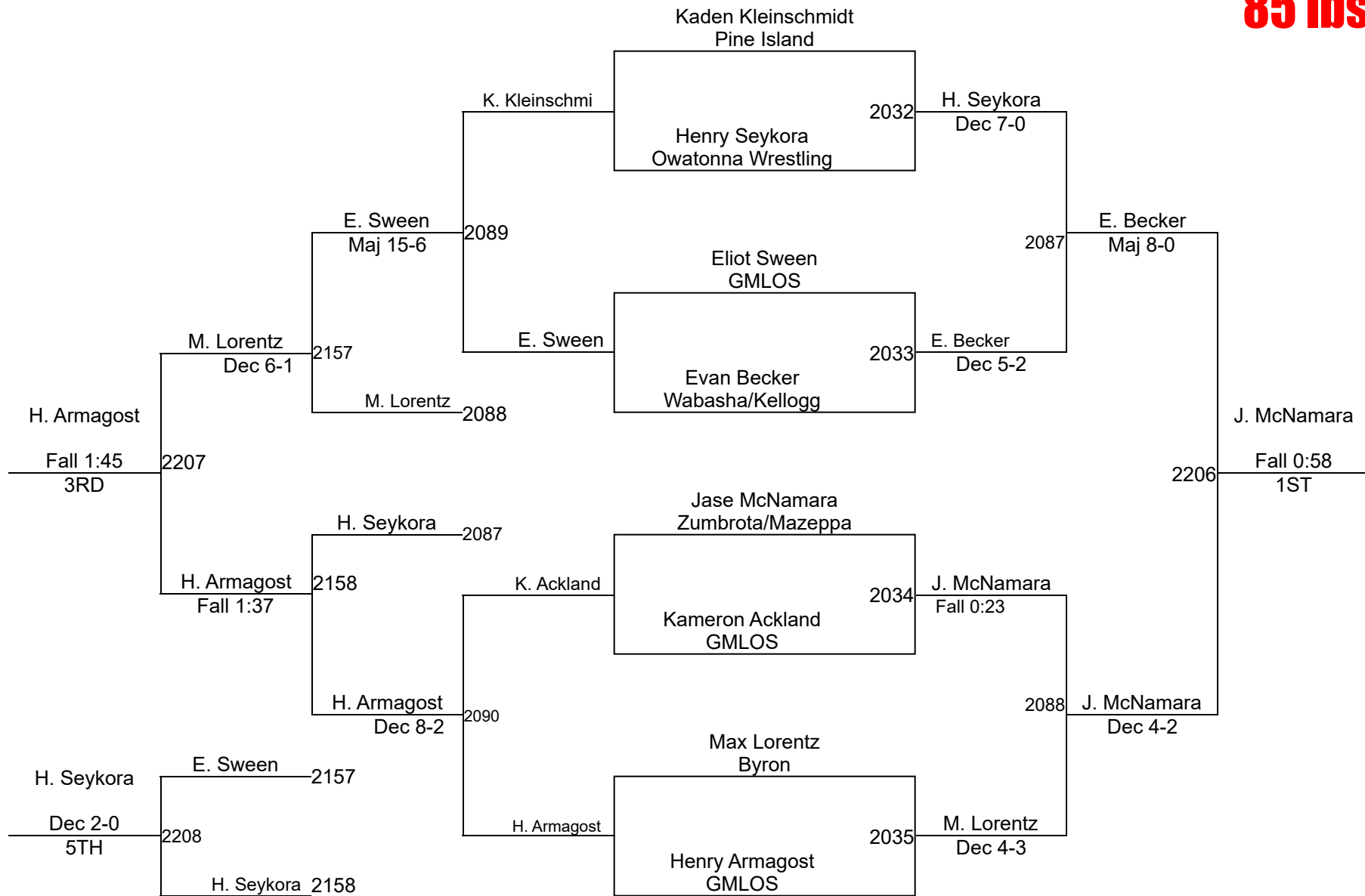

# NYWA Regional (Byron)

**3rd & 4th  
90 lbs**

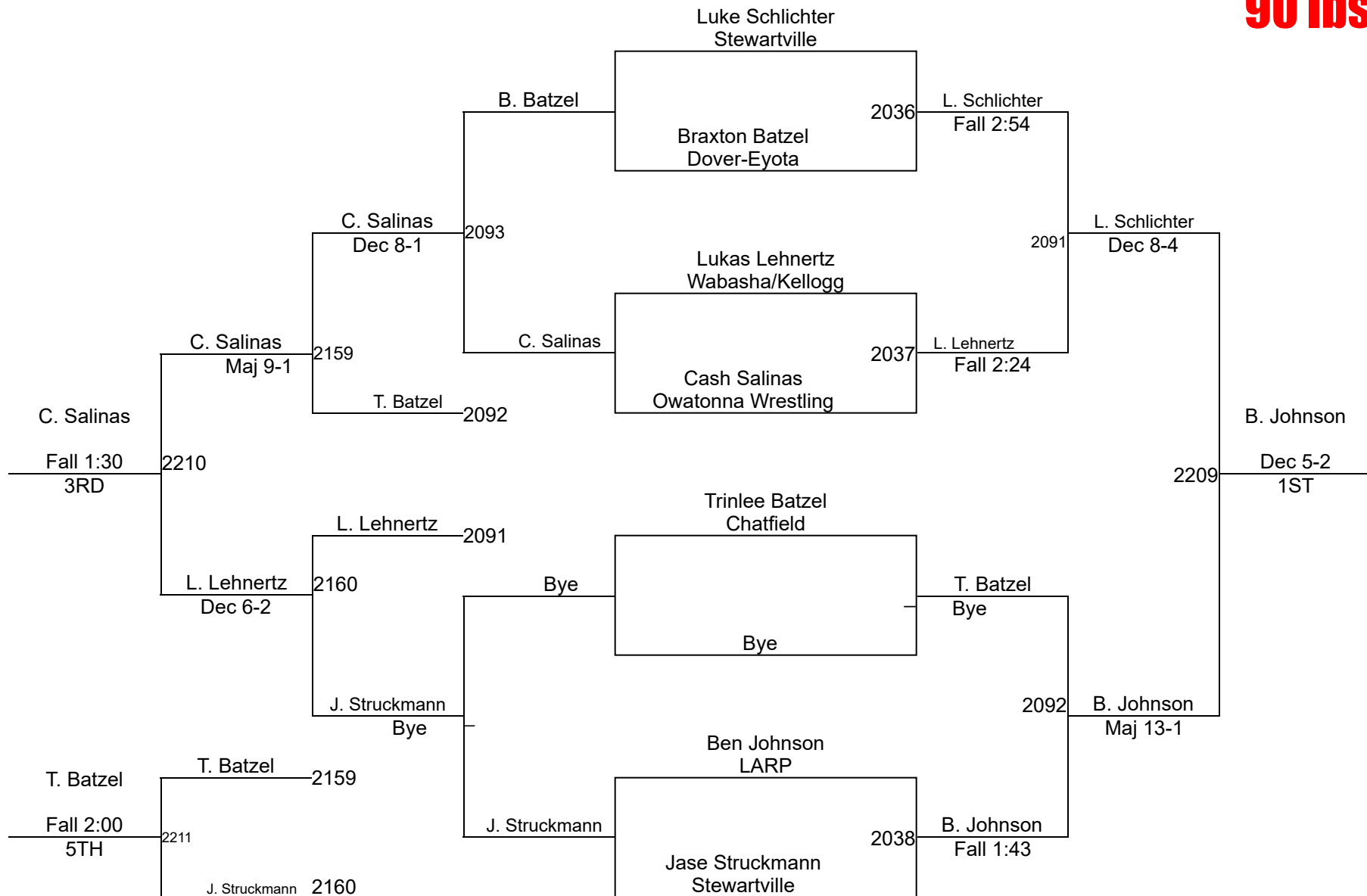

# NYWA Regional (Byron)

**3rd & 4th  
95 lbs**

## Round 1

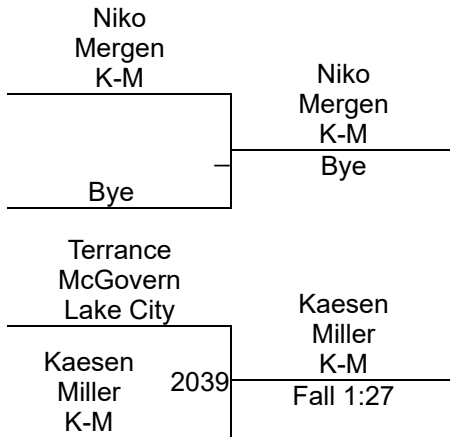

## Round 2

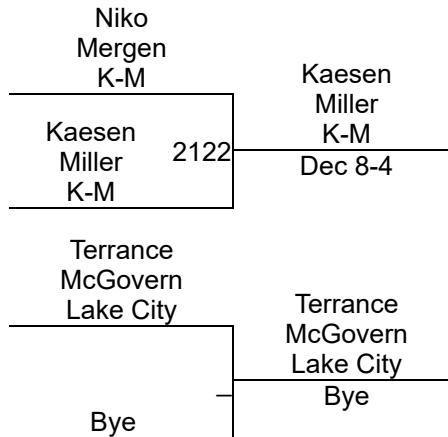

## Round 3

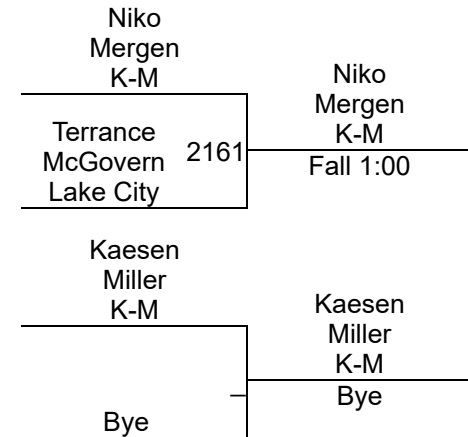

### WRESTLERS

- N. Mergen (K-M)
- Bye
- T. McGovern (Lake City)
- K. Miller (K-M)

- K. Miller (K-M)

---

- 1ST**
- N. Mergen (K-M)

---

- 2ND**
- T. McGovern (Lake City)

---

- 3RD**
- Bye

---

- 4TH**





# NYWA Regional (Byron)

**3rd & 4th**  
**105 lbs**

Round 1

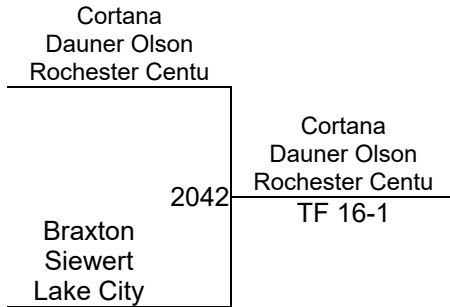

Round 2

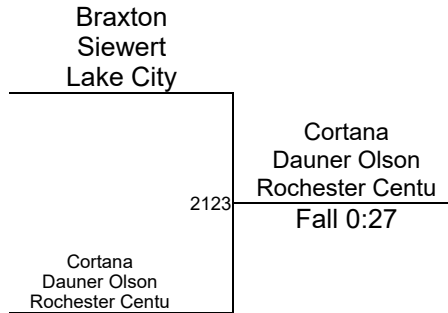

Round 3

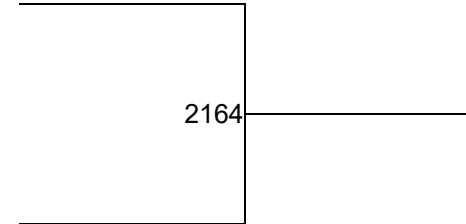

C. Dauner Olson (Rochester Century)  
**1ST**

B. Siewert (Lake City)  
**2ND**

# NYWA Regional (Byron)

**3rd & 4th  
110 lbs**

Round 1

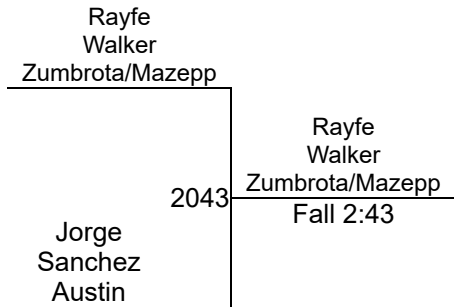

Round 2

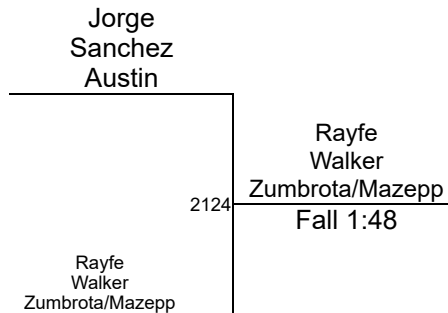

Round 3

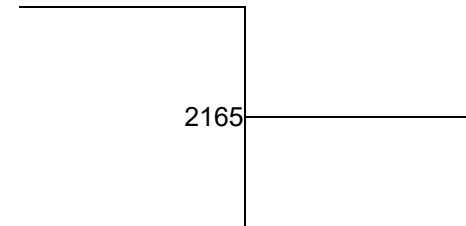

R. Walker (Zumbrota/Mazeppa)

**1ST**

J. Sanchez (Austin)

**2ND**

# NYWA Regional (Byron)

**3rd & 4th  
115 lbs**

## Round 1

Weston Todd Plainview/Elgin	Colton Varpness Dover-Eyota	2044	Fall 2:35
Brooks Soberg K-M	Weston Hoebing Westfield	2045	Dec 1-0

## Round 2

Weston Todd Plainview/Elgin	Weston Hoebing Westfield	2125	Maj 13-2
Brooks Soberg K-M	Colton Varpness Dover-Eyota	2126	Maj 12-0

## Round 3

Weston Todd Plainview/Elgin	Brooks Soberg K-M	2166	DQ
Weston Hoebing Westfield	Colton Varpness Dover-Eyota	2167	Fall 2:33

## WRESTLERS

W. Todd (Plainview/Elgin/Millville)

C. Varpness (Dover-Eyota)

B. Soberg (K-M)

W. Hoebing (Westfield)

C. Varpness (Dover-Eyota)

**1ST**

W. Hoebing (Westfield)

**2ND**

B. Soberg (K-M)

**3RD**

W. Todd (Plainview/Elgin/Millville)

**4TH**

# NYWA Regional (Byron)

**3rd & 4th**  
**155 lbs**

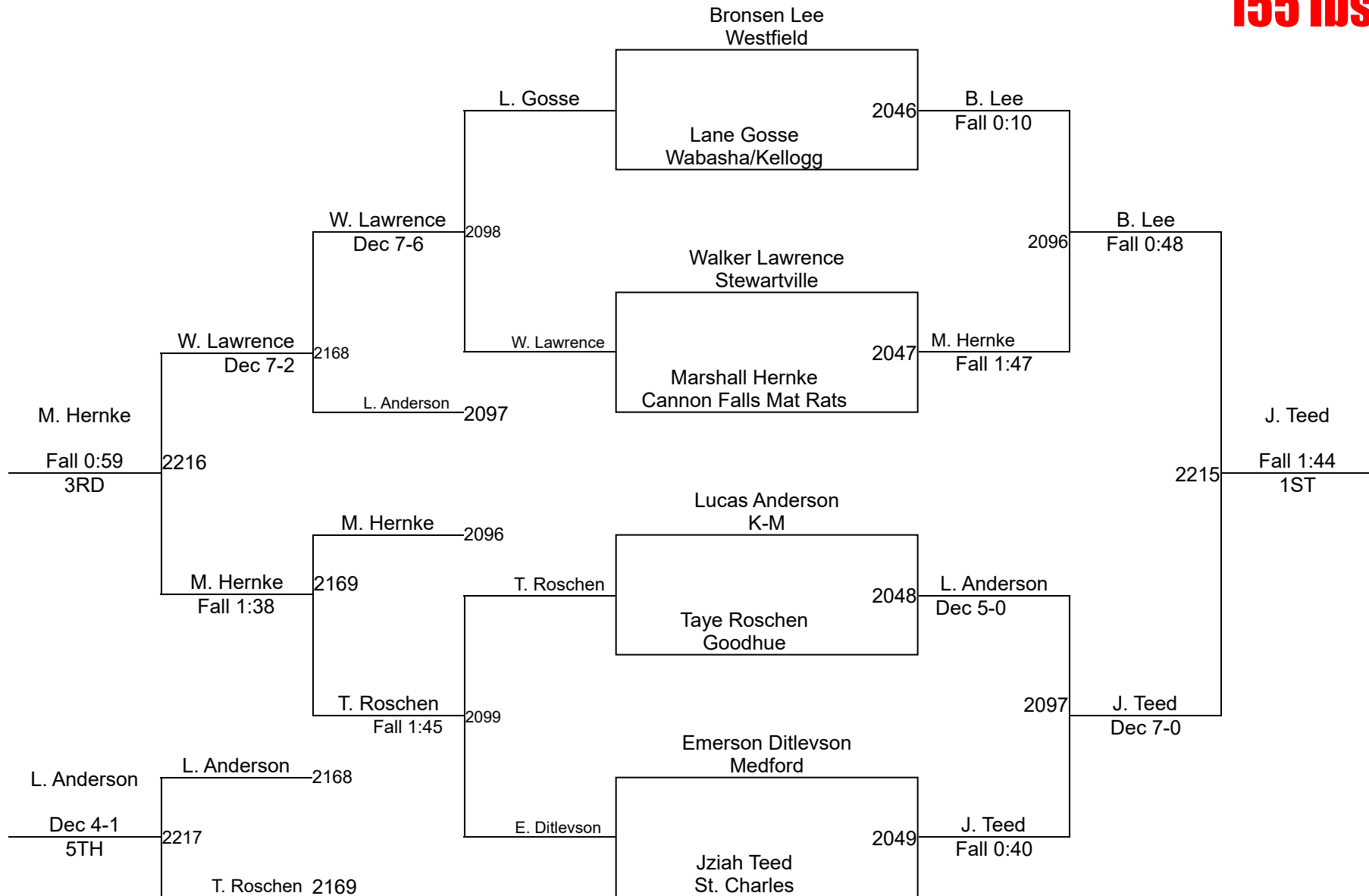

# NYWA Regional (Byron)

**5th & 6th  
65 lbs**

## Round 1

Teddy O'Connor Zumbrota/Mazepp	Henry Luhman Goodhue	218	Henry Luhman Goodhue Dec 4-0
Charlie Staudacher Winona	Bye		Charlie Staudacher Winona Bye

## Round 2

Teddy O'Connor Zumbrota/Mazepp	Bye		Teddy O'Connor Zumbrota/Mazepp Bye
Charlie Staudacher Winona	Henry Luhman Goodhue	585	Henry Luhman Goodhue Dec 4-0

## Round 3

Teddy O'Connor Zumbrota/Mazepp	Charlie Staudacher Winona	741	Charlie Staudacher Winona Dec 4-0
Bye	Henry Luhman Goodhue		Henry Luhman Goodhue Bye

## WRESTLERS

T. O'Connor (Zumbrota/Mazeppa)

H. Luhman (Goodhue)

C. Staudacher (Winona)

Bye

H. Luhman (Goodhue)

**1ST**

C. Staudacher (Winona)

**2ND**

T. O'Connor (Zumbrota/Mazeppa)

**3RD**

Bye

**4TH**

# NYWA Regional (Byron)

**5th & 6th**  
**70 lbs**

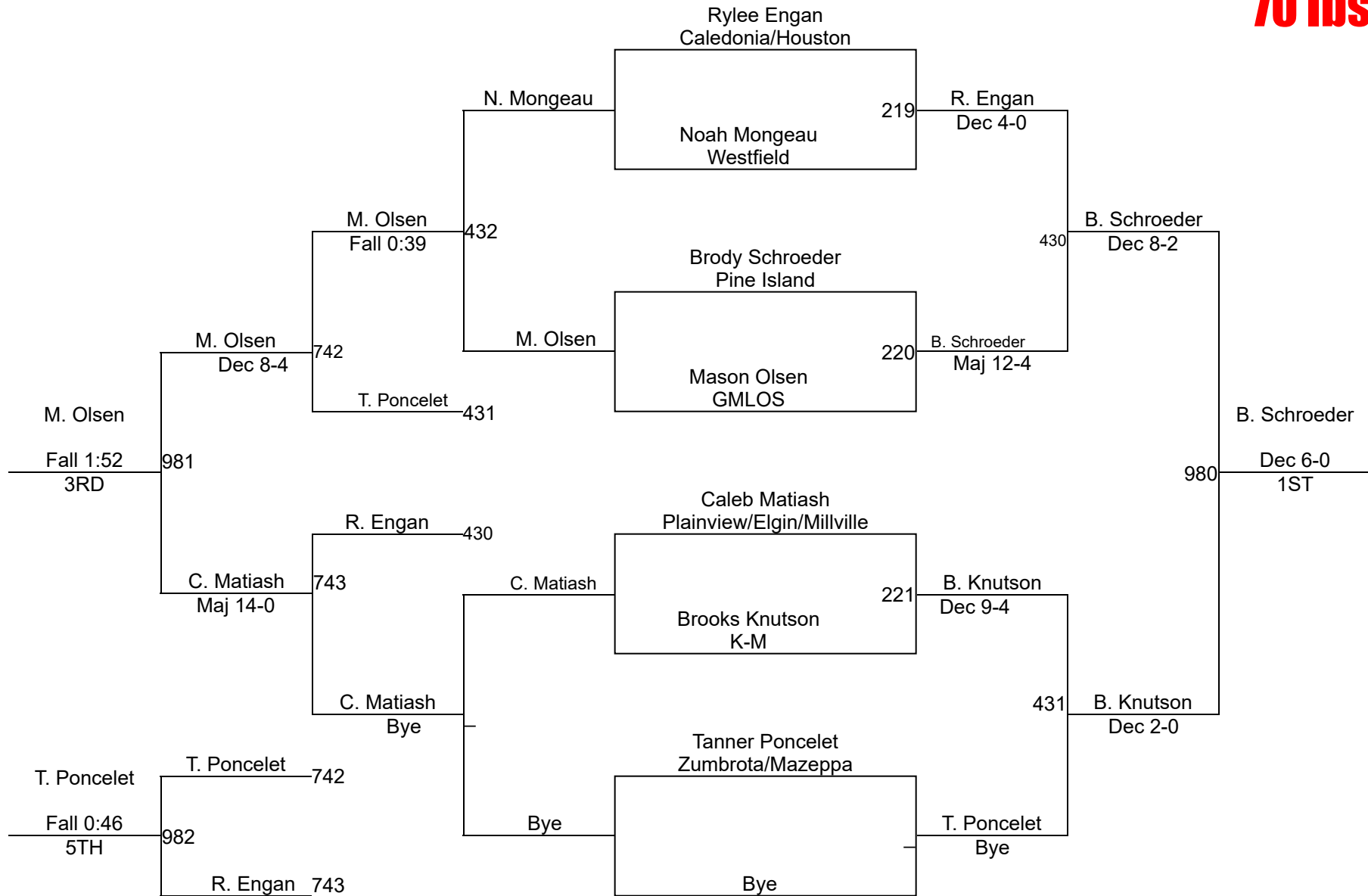

# NYWA Regional (Byron)

**5th & 6th  
75 lbs**

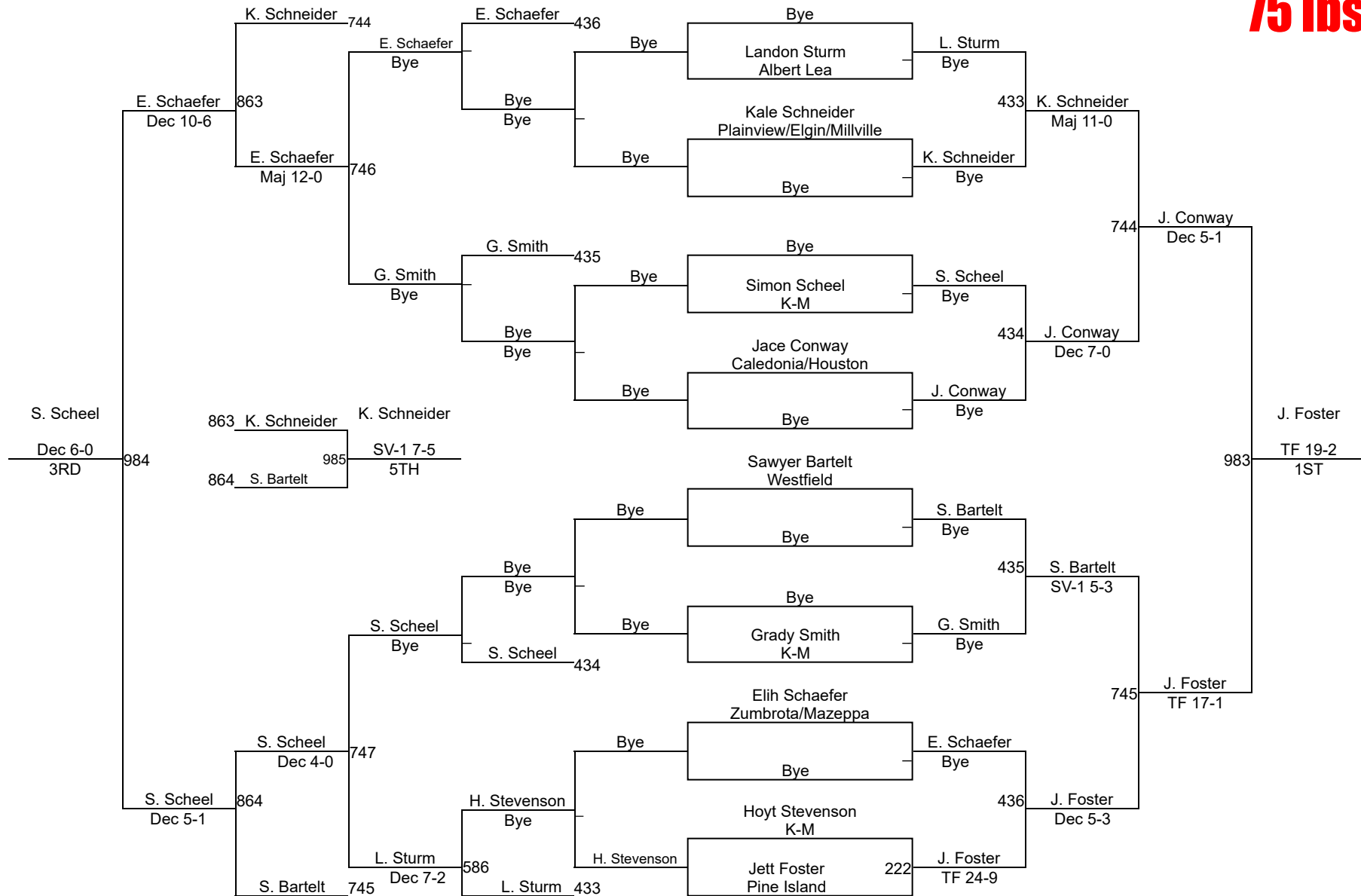

# NYWA Regional (Byron)

**5th & 6th  
80 lbs**

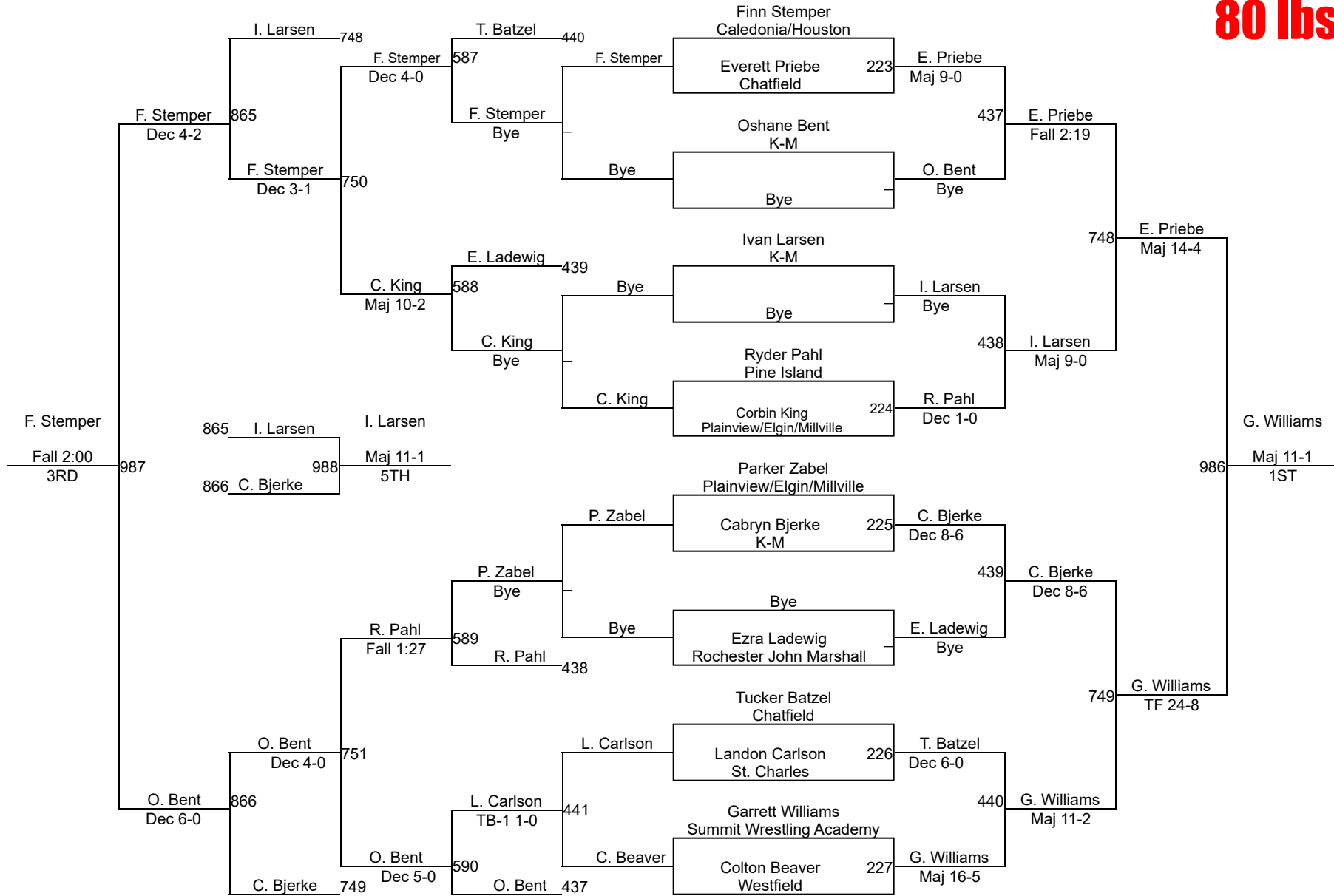



# NYWA Regional (Byron)

# 5th & 6th 84

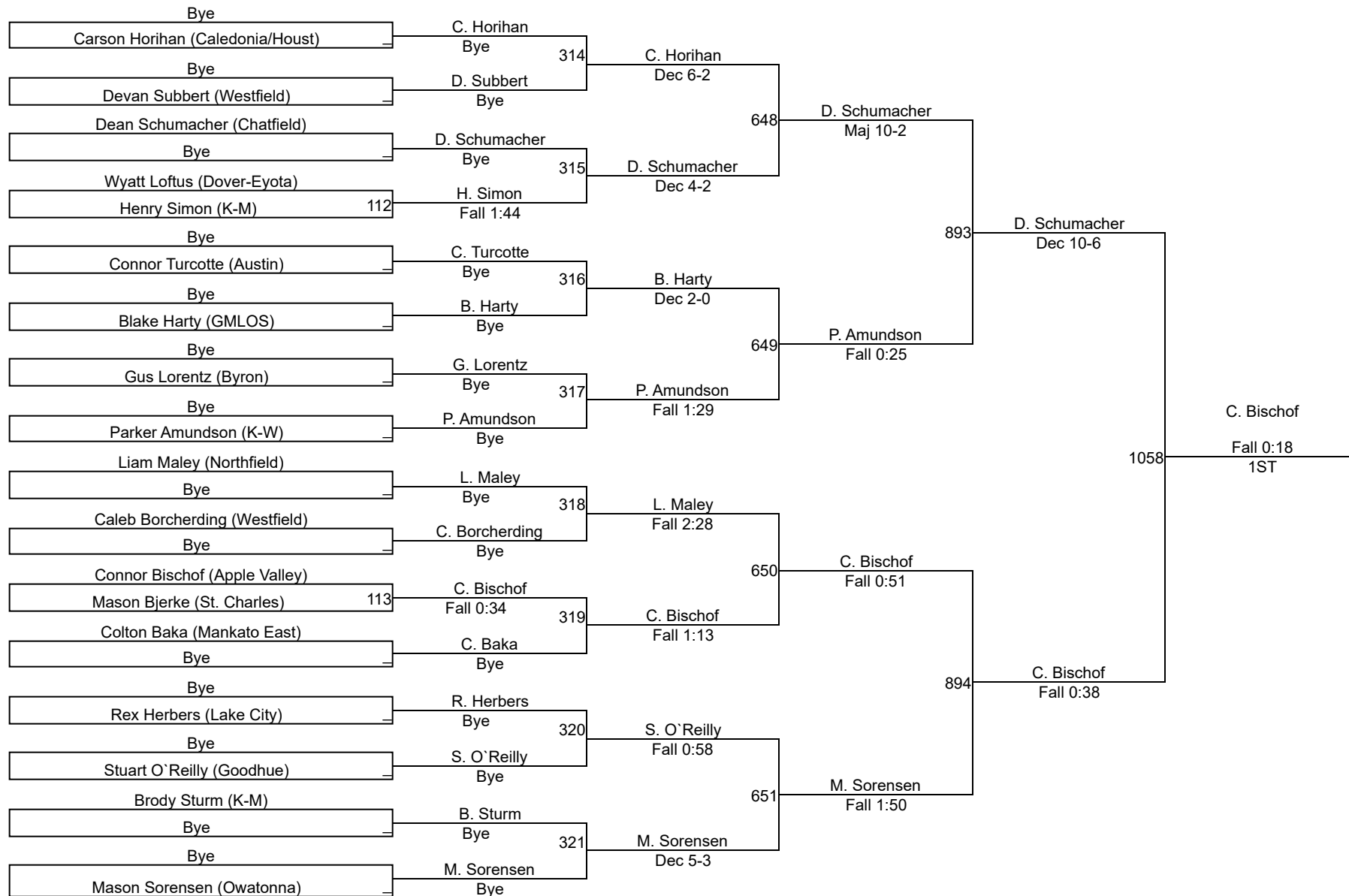

# 5th & 6th 84

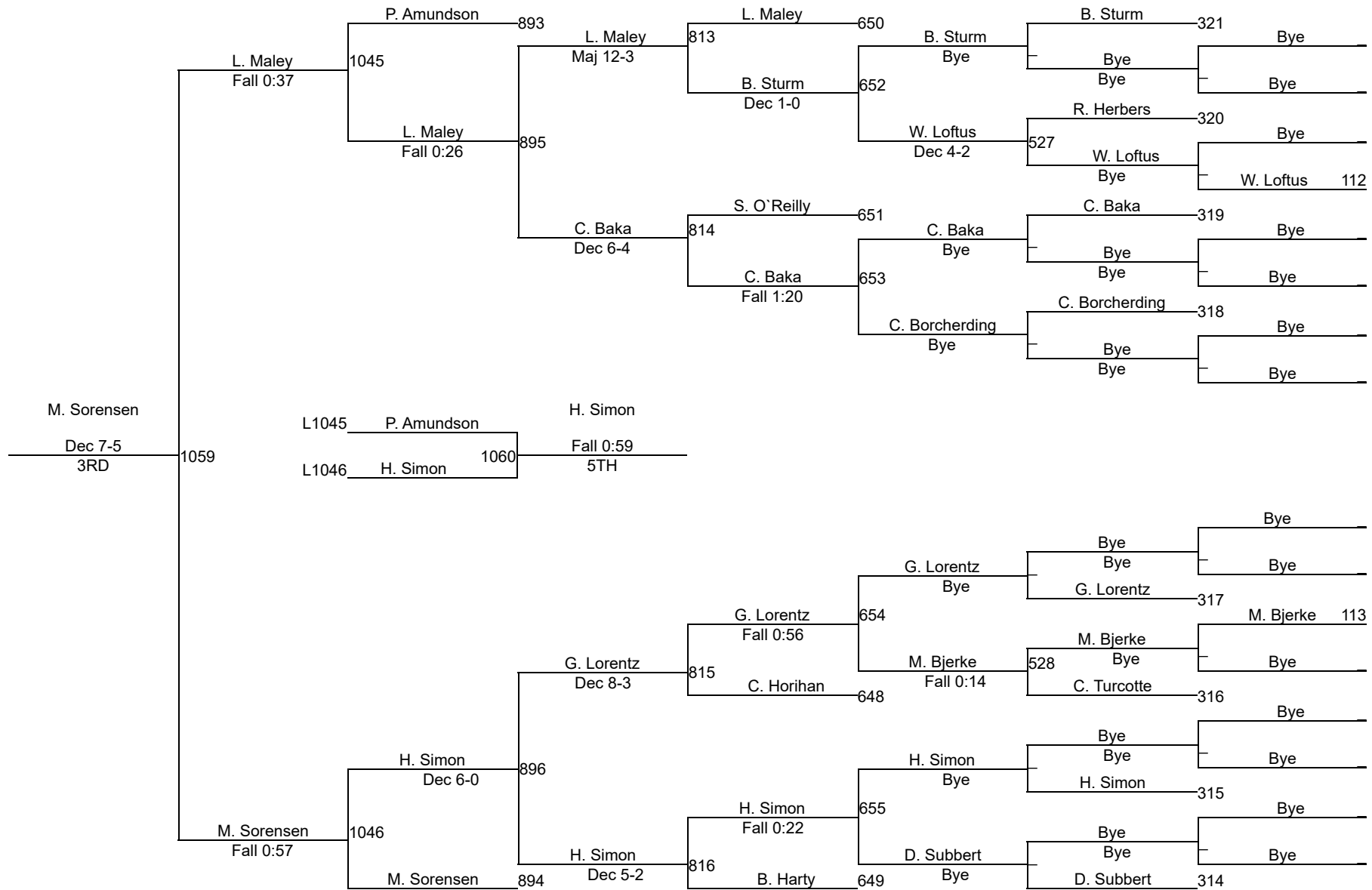

# NYWA Regional (Byron)

**5th & 6th 88**

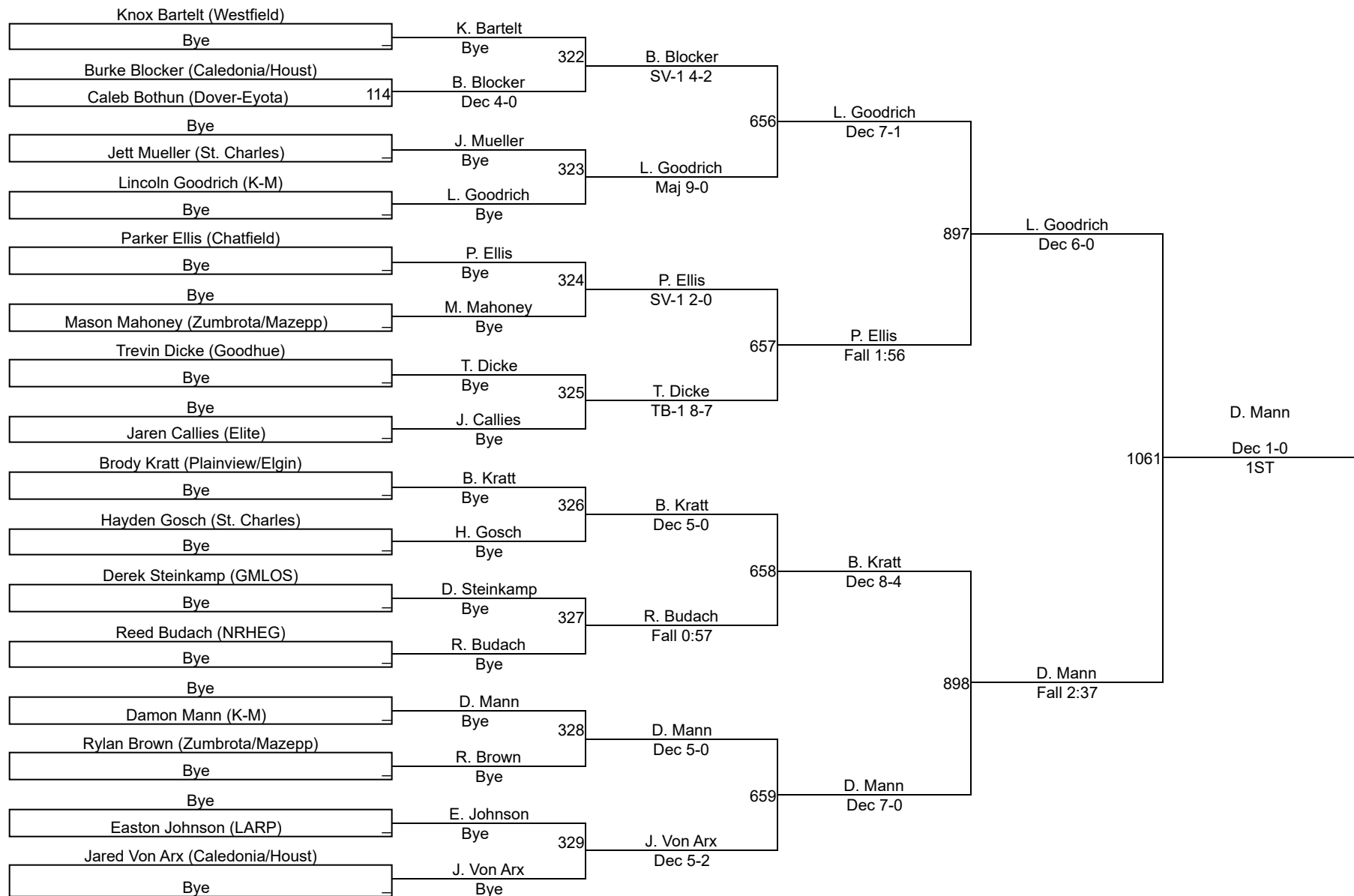

# 5th & 6th 88

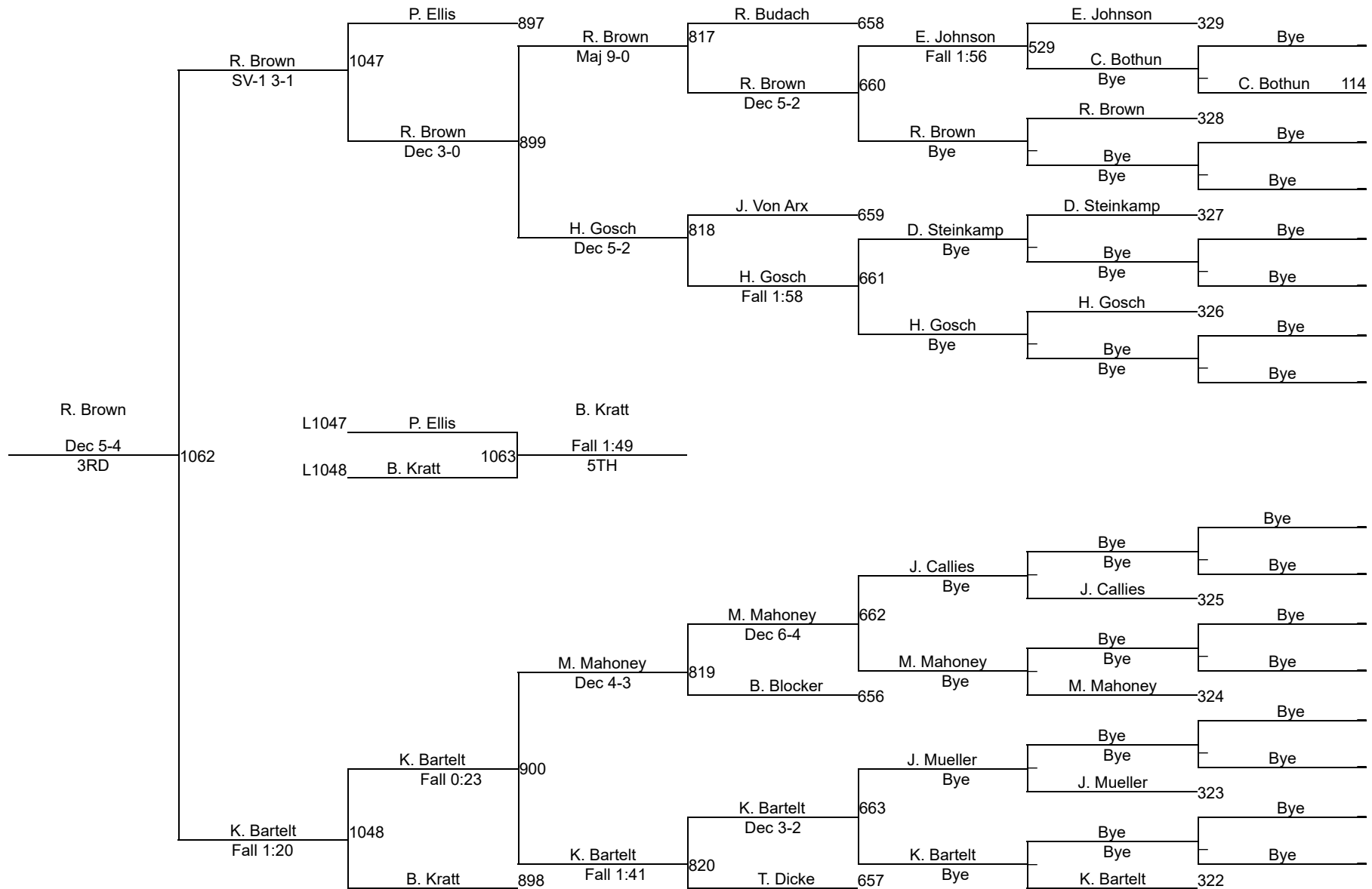

# NYWA Regional (Byron)

**5th & 6th**  
**93 lbs**

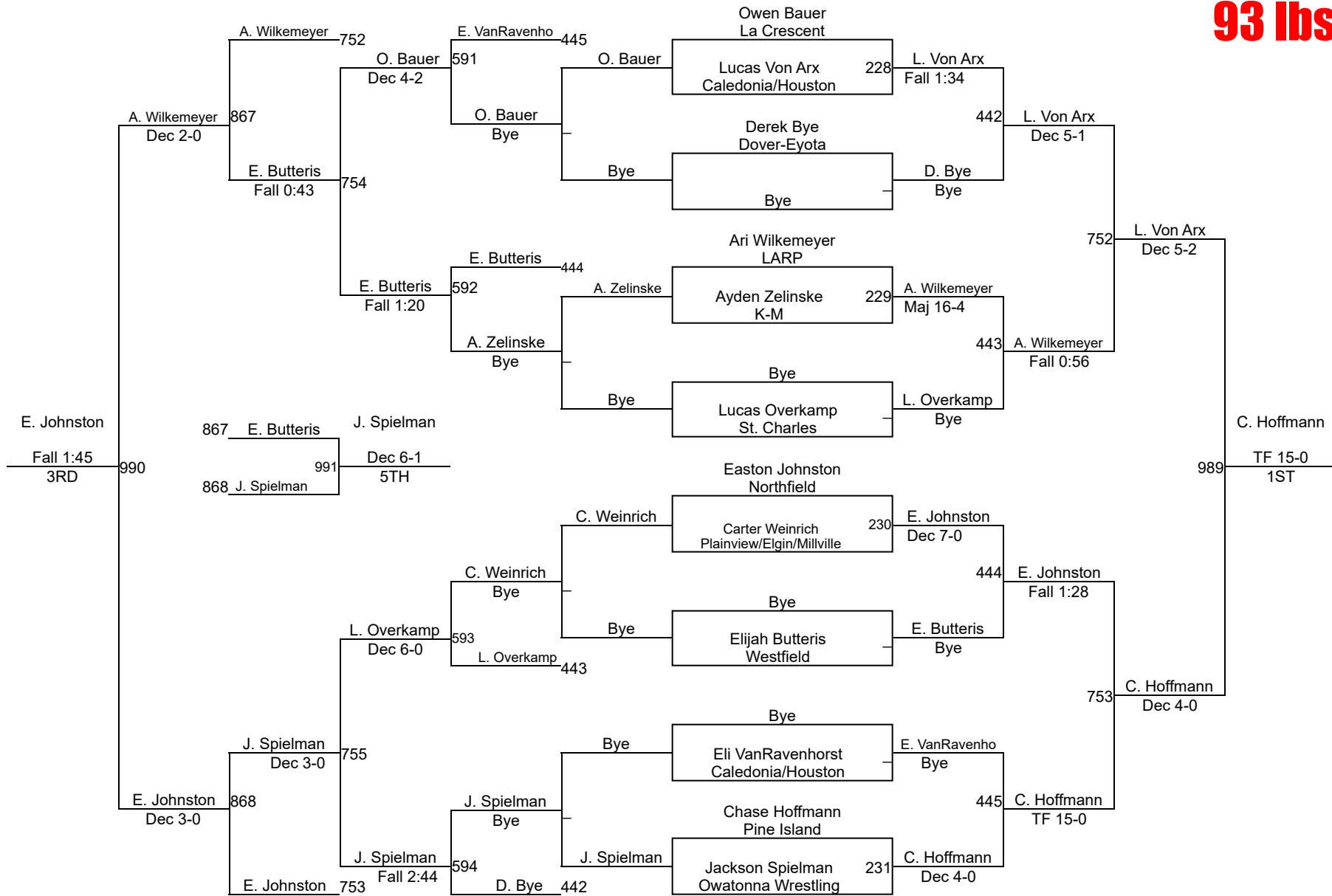

# NYWA Regional (Byron)

**5th & 6th**  
**97 lbs**

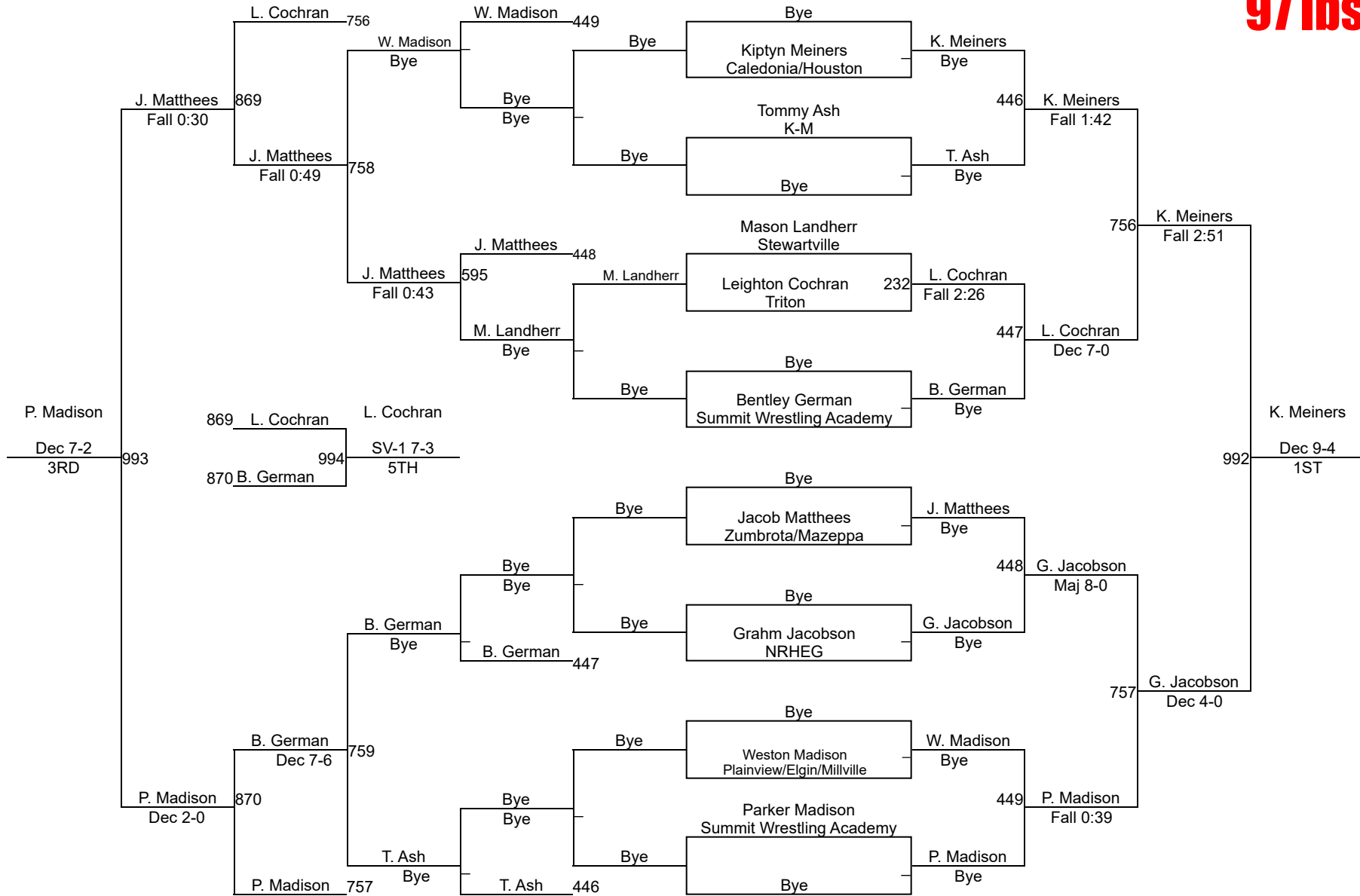

# NYWA Regional (Byron)

**5th & 6th**  
**102 lbs**

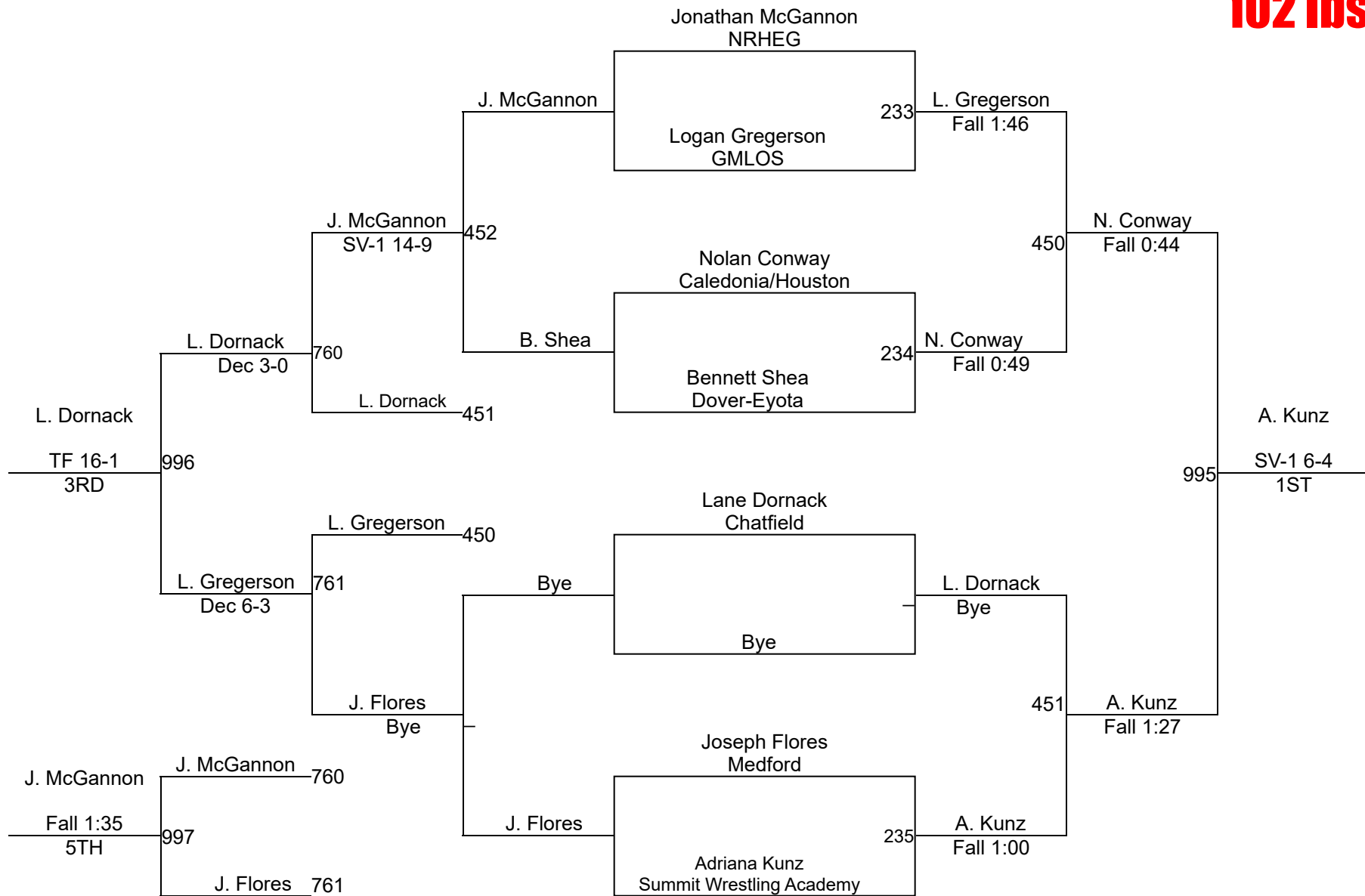

# NYWA Regional (Byron)

**5th & 6th**  
**108 lbs**

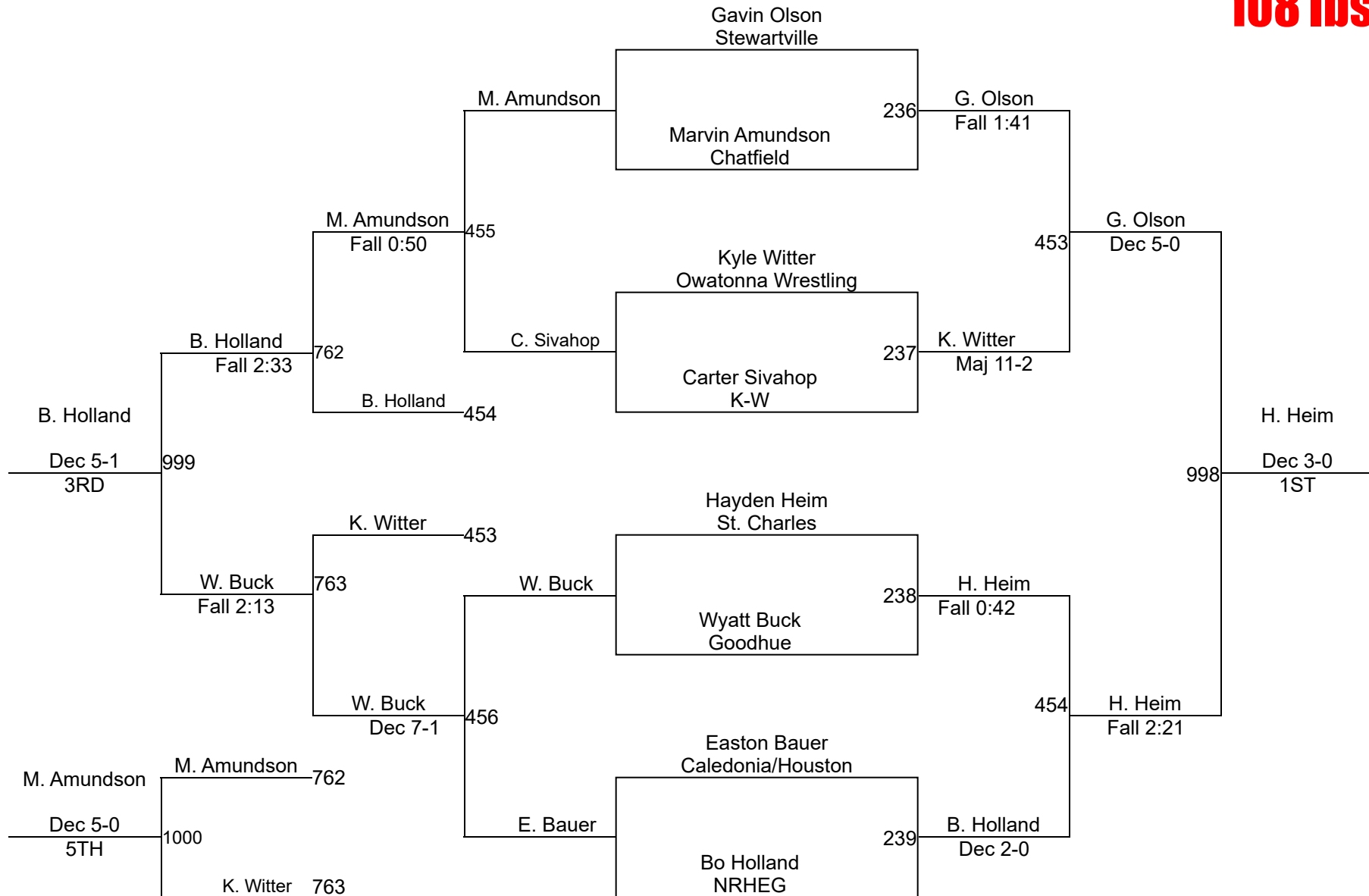



# NYWA Regional (Byron)

**5th & 6th  
115 lbs**

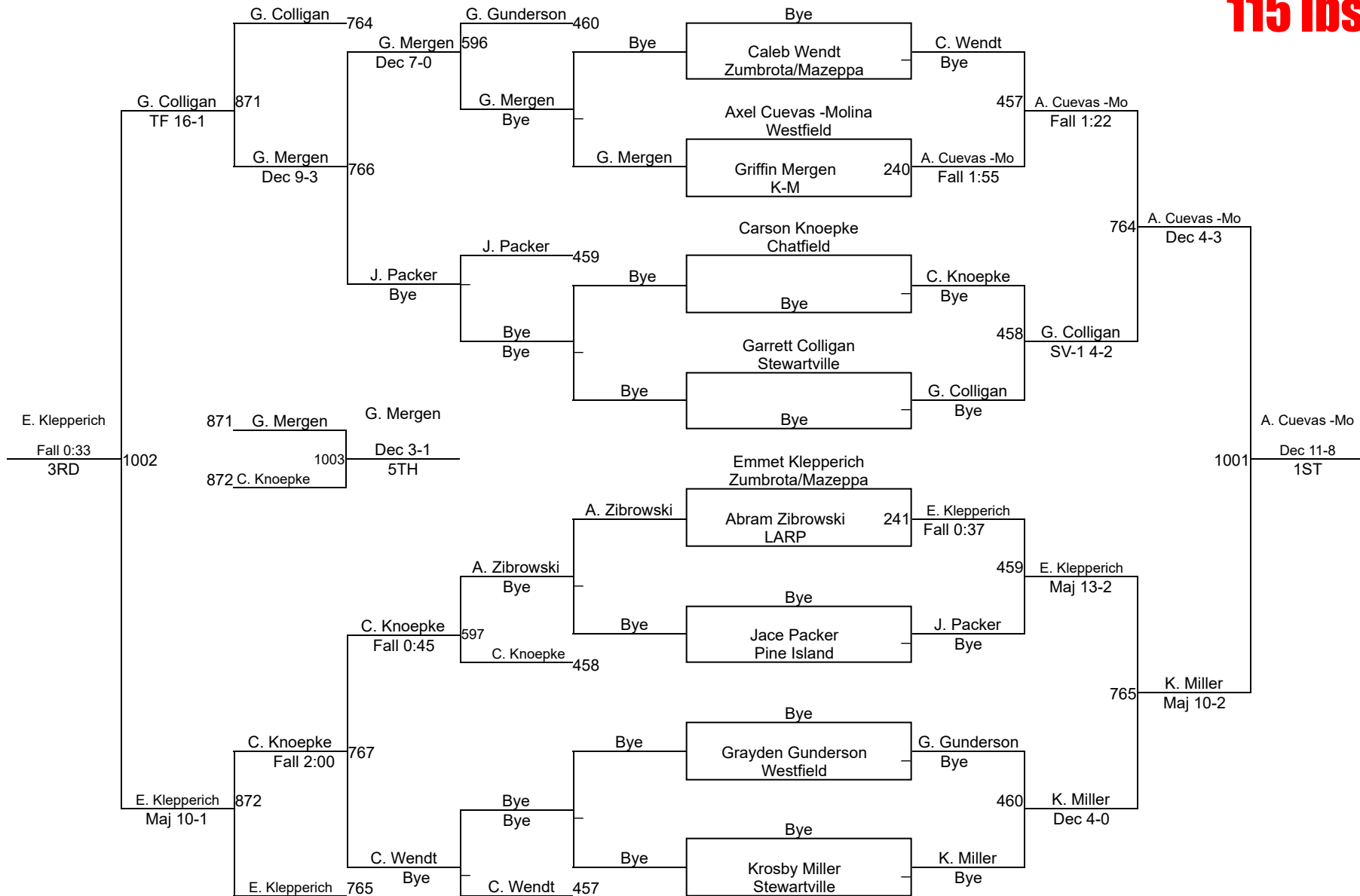

# NYWA Regional (Byron)

# 5th & 6th 120

E. Burt	E. Burt
Bye	Bye

E. Burt	L. Roberson
L. Roberson 502	Fall 1:36

E. Burt	D. Nelson
D. Nelson 610	TF 16-1

E. Burt	E. English
E. English 823	Fall 0:27

E. Burt	N. Adams
N. Adams 903	Fall 2:37

## Round 1

N. Adams	E. English
E. English 276	Fall 2:59

## Round 2

N. Adams	D. Nelson
D. Nelson 503	TF 17-1

## Round 3

N. Adams	N. Adams
Bye	Bye

## Round 4

N. Adams	L. Roberson
L. Roberson 824	Dec 4-0

## Round 5

E. English	D. Nelson
D. Nelson 904	Fall 0:56

D. Nelson	D. Nelson
L. Roberson 277	TF 17-2

E. English	E. English
Bye	Bye

E. English	E. English
L. Roberson 611	Fall 0:35

D. Nelson	D. Nelson
Bye	Bye

L. Roberson	L. Roberson
Bye	Bye

Danan Nelson (Summit Wrestling Academy)

**1ST**

Ethan English (Stewartville)

**2ND**

Liam Roberson (Rochester Mayo)

**3RD**

Nathaniel Adams (JWP/WEM)

**4TH**

Easton Burt (Dover-Eyota)

**5TH**

Bye

**6TH**

# NYWA Regional (Byron)

**5th & 6th**  
**130 lbs**

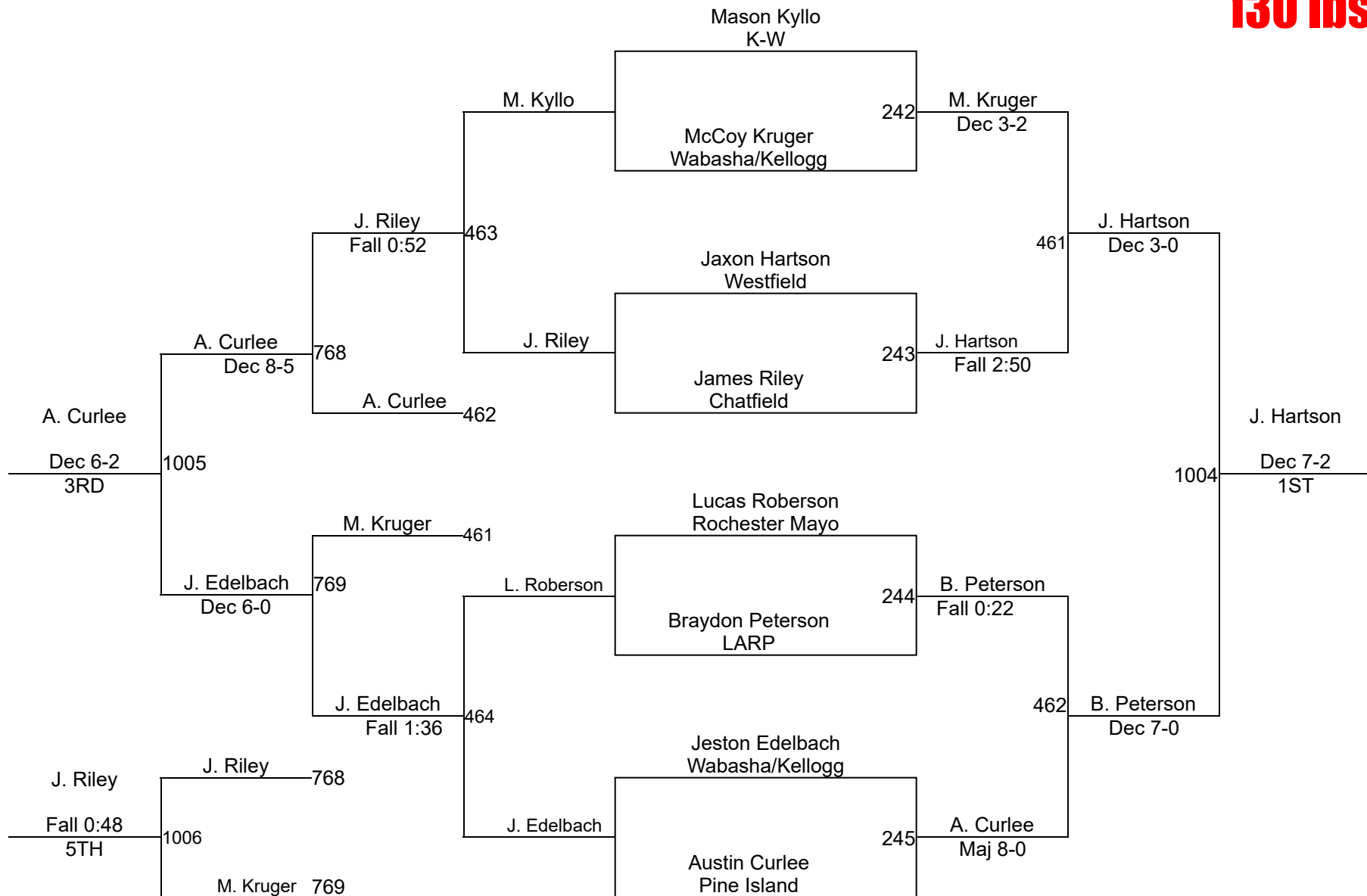

# NYWA Regional (Byron)

R. Wilson		R. Wilson
J. Clennon	278	Fall 0:15

R. Wilson		R. Wilson
M. Desens	504	Fall 0:21

R. Wilson		R. Wilson
H. McFarland	612	Dec 7-1

R. Wilson		R. Wilson
Bye		Bye

R. Wilson		R. Wilson
T. Martell	905	Fall 0:18

## Round 1

T. Martell		T. Martell
Bye		Bye

## Round 2

T. Martell		T. Martell
H. McFarland	505	Fall 0:58

## Round 3

T. Martell		J. Clennon
J. Clennon	613	TF 16-0

## Round 4

T. Martell		T. Martell
M. Desens	825	Dec 9-4

## Round 5

Bye		H. McFarland
H. McFarland		Bye

# 5th & 6th 140

H. McFarland		M. Desens
M. Desens	279	SV-1 2-0

Bye		J. Clennon
J. Clennon		Bye

Bye		M. Desens
M. Desens		Bye

H. McFarland		H. McFarland
J. Clennon	826	SV-1 7-5

M. Desens		J. Clennon
J. Clennon	906	Dec 3-2

Rogan Wilson (GMLOS)

**1ST**

Jameson Clennon (Westfield)

**2ND**

Tucker Martell (Caledonia/Houston)

**3RD**

Matthew Desens (Dover-Eyota)

**4TH**

Hunter McFarland (NRHEG)

**5TH**

Bye

**6TH**

# NYWA Regional (Byron)

**5th & 6th**  
**155 lbs**

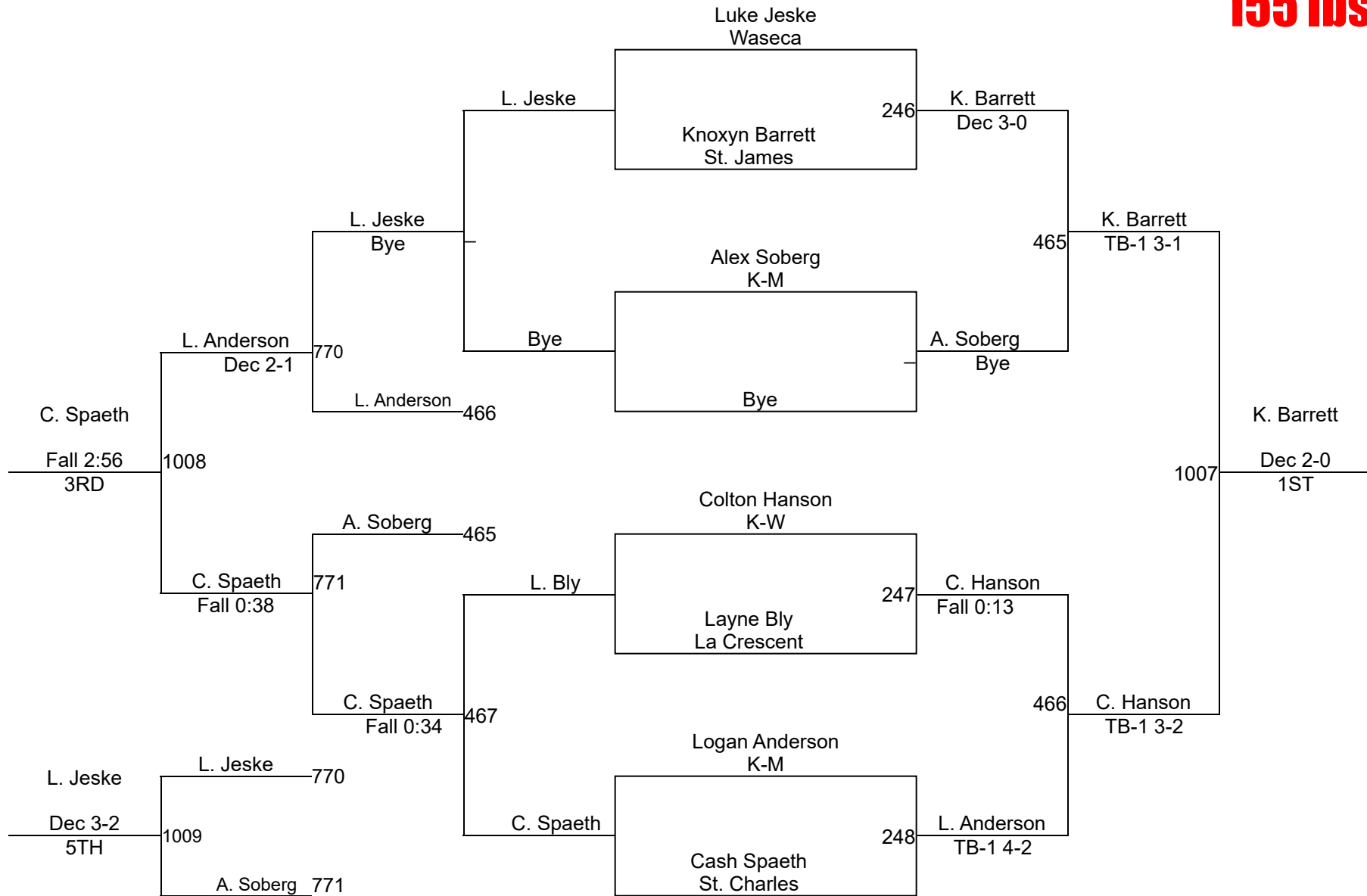

# NYWA Regional (Byron)

# 5th & 6th 215

T. Skime		T. Skime
Bye	-	Bye

T. Skime		B. Spaeth
B. Spaeth	506	Fall 1:21

T. Skime		T. Skime
T. Heinz	614	Fall 0:53

T. Skime		T. Skime
C. Dornink	827	Fall 0:35

T. Skime		T. Skime
K. Gaddis	907	Fall 0:13

## Round 1

K. Gaddis		C. Dornink
C. Dornink	280	Fall 2:34

## Round 2

K. Gaddis		T. Heinz
T. Heinz	507	Fall 0:48

## Round 3

K. Gaddis		K. Gaddis
Bye	-	Bye

## Round 4

K. Gaddis		B. Spaeth
B. Spaeth	828	Fall 0:13

## Round 5

C. Dornink		C. Dornink
T. Heinz	908	Fall 1:13

T. Heinz		B. Spaeth
B. Spaeth	281	Fall 0:49

C. Dornink		C. Dornink
Bye	-	Bye

C. Dornink		B. Spaeth
B. Spaeth	615	Fall 0:50

T. Heinz		T. Heinz
Bye	-	Bye

B. Spaeth		B. Spaeth
Bye	-	Bye

Blayz Spaeth (St. Charles)

**1ST**

Tanner Skime (Westfield)

**2ND**

Cooper Dornink (Wabasha/Kellogg)

**3RD**

Tanner Heinz (Austin)

**4TH**

Kaison Gaddis (Byron)

**5TH**

Bye

**6TH**

# NYWA Regional (Byron)

**7th & 8th  
80 lbs**

## Round 1

Grayson Schroeder Pine Island		Grayson Schroeder Pine Island	
Benjamin Gadient Goodhue	249	TF 20-5	
Brycen Kothenbeutel Pine Island		Brycen Kothenbeutel Pine Island	
Bye		Bye	

## Round 2

Grayson Schroeder Pine Island		Grayson Schroeder Pine Island	
Bye		Bye	
Brycen Kothenbeutel Pine Island		Brycen Kothenbeutel Pine Island	
Benjamin Gadient Goodhue	598	Dec 4-1	

## Round 3

Grayson Schroeder Pine Island		Grayson Schroeder Pine Island	
Brycen Kothenbeutel Pine Island	772	Maj 13-3	
Bye		Benjamin Gadient Goodhue	
Benjamin Gadient Goodhue		Bye	

## WRESTLERS

G. Schroeder (Pine Island)

B. Gadient (Goodhue)

B. Kothenbeutel (Pine Island)

Bye

G. Schroeder (Pine Island)

**1ST**

B. Kothenbeutel (Pine Island)

**2ND**

B. Gadient (Goodhue)

**3RD**

Bye

**4TH**

# NYWA Regional (Byron)

# 7th & 8th 85

J. Knish		M. Zabel
M. Zabel	282	Maj 12-3

J. Knish		E. Hanson
E. Hanson	508	Maj 8-0

J. Knish		J. Knish
Bye		Bye

J. Knish		K. Pastika
K. Pastika	829	Dec 6-4

J. Knish		J. Knish
J. Fischer	909	Fall 1:04

## Round 1

J. Fischer		K. Pastika
K. Pastika	283	Fall 3:37

## Round 2

J. Fischer		J. Fischer
Bye		Bye

## Round 3

J. Fischer		M. Zabel
M. Zabel	616	Fall 0:47

## Round 4

J. Fischer		E. Hanson
E. Hanson	830	Fall 0:43

## Round 5

K. Pastika		K. Pastika
Bye		Bye

Bye		E. Hanson
E. Hanson		Bye

K. Pastika		M. Zabel
M. Zabel	509	Dec 7-2

K. Pastika		E. Hanson
E. Hanson	617	Maj 11-1

Bye		M. Zabel
M. Zabel		Bye

E. Hanson		M. Zabel
M. Zabel	910	Dec 4-2

Mason Zabel (Plainview/Elgin/Millville)

**1ST**

Eli Hanson (K-W)

**2ND**

Kayla Pastika (Owatonna)

**3RD**

Jacksten Knish (WEM/JWP)

**4TH**

Jackson Fischer (FCLMC)

**5TH**

Bye

**6TH**



# NYWA Regional (Byron)

**7th & 8th**  
**90 lbs**

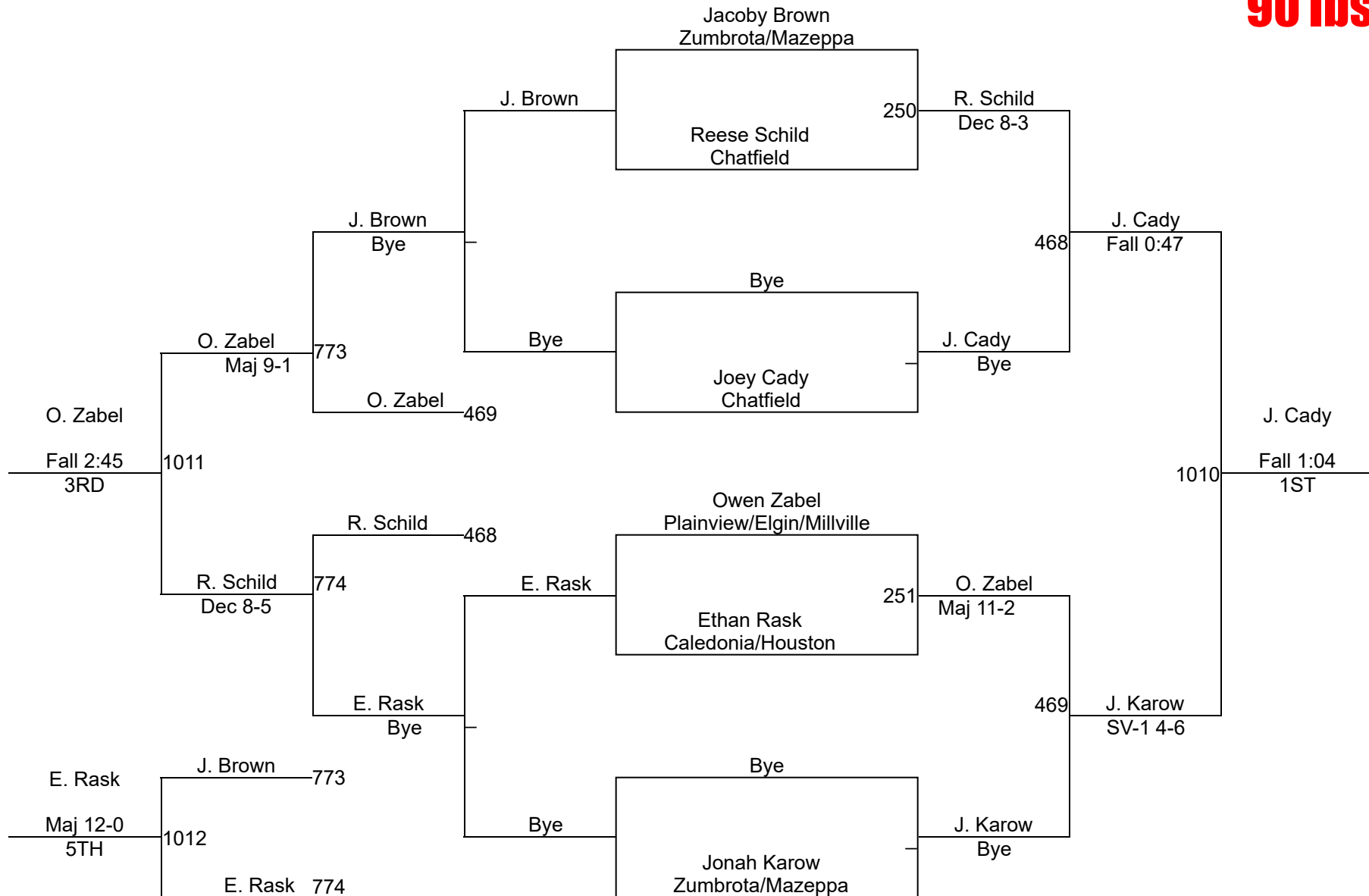

# NYWA Regional (Byron)

# 7th & 8th 95

B. Miller		B. Miller
Bye		Bye

B. Miller		B. Miller
B. Norby	510	Fall 2:23

B. Miller		B. Miller
C. LaFee	618	MFF

B. Miller		B. Miller
L. Matthees	831	Dec 2-0

B. Miller		B. Miller
A. Von Knobelsdorf	911	Dec 4-0

## Round 1

A. Von Knobelsdorf		L. Matthees
L. Matthees	284	Maj 10-0

## Round 2

A. Von Knobelsdorf		A. Von Knobelsdorf
C. LaFee	511	Fall 3:00

## Round 3

A. Von Knobelsdorf		A. Von Knobelsdorf
Bye		Bye

## Round 4

A. Von Knobelsdorf		A. Von Knobelsdorf
B. Norby	832	Fall 3:33

## Round 5

L. Matthees		L. Matthees
C. LaFee	912	Inj. 0:00

C. LaFee		C. LaFee
B. Norby	285	Fall 2:48

L. Matthees		L. Matthees
Bye		Bye

L. Matthees		L. Matthees
B. Norby	619	Fall 1:12

C. LaFee		C. LaFee
Bye		Bye

B. Norby		B. Norby
Bye		Bye

Bentley Miller (Westfield)

**1ST**

Levi Matthees (Zumbrota/Mazeppa)

**2ND**

Arlyn Von Knobelsdorf (Goodhue)

**3RD**

Carter LaFee (LARP)

**4TH**

Ben Norby (FCLMC)

**5TH**

Bye

**6TH**

# NYWA Regional (Byron)

**7th & 8th  
100 lbs**

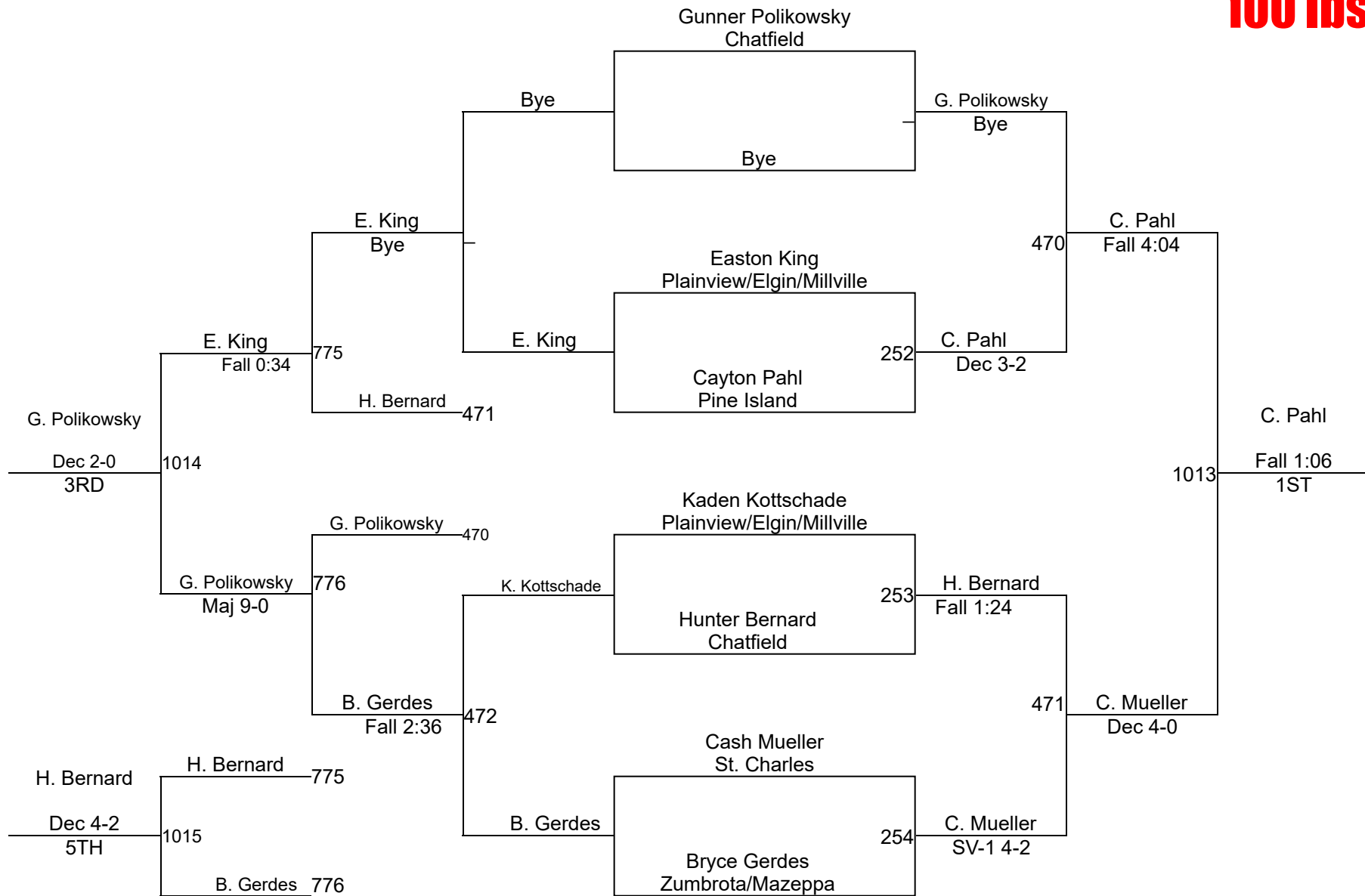

# NYWA Regional (Byron)

**7th & 8th**  
**105 lbs**

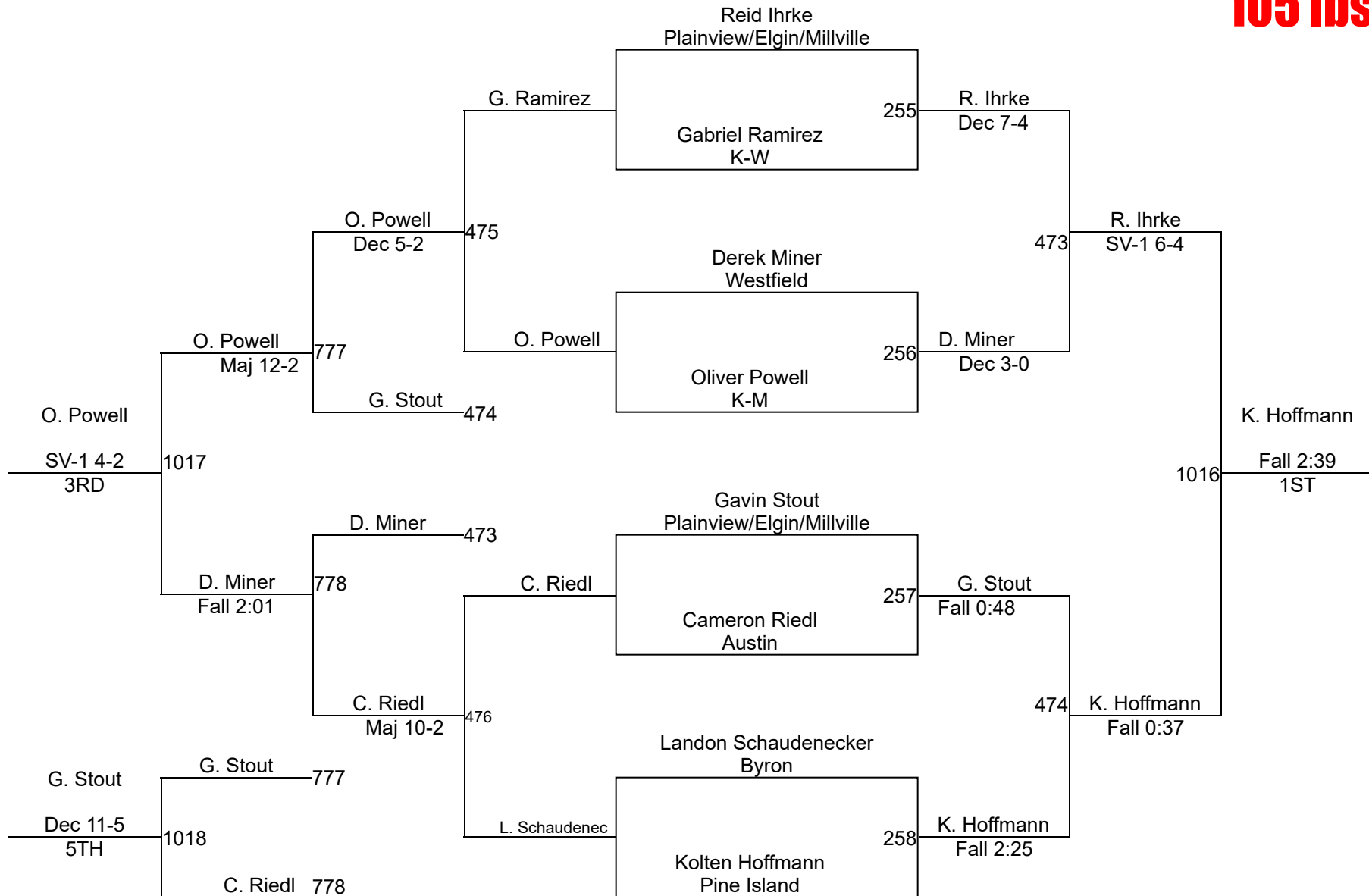

# NYWA Regional (Byron)

**7th & 8th**  
**110 lbs**

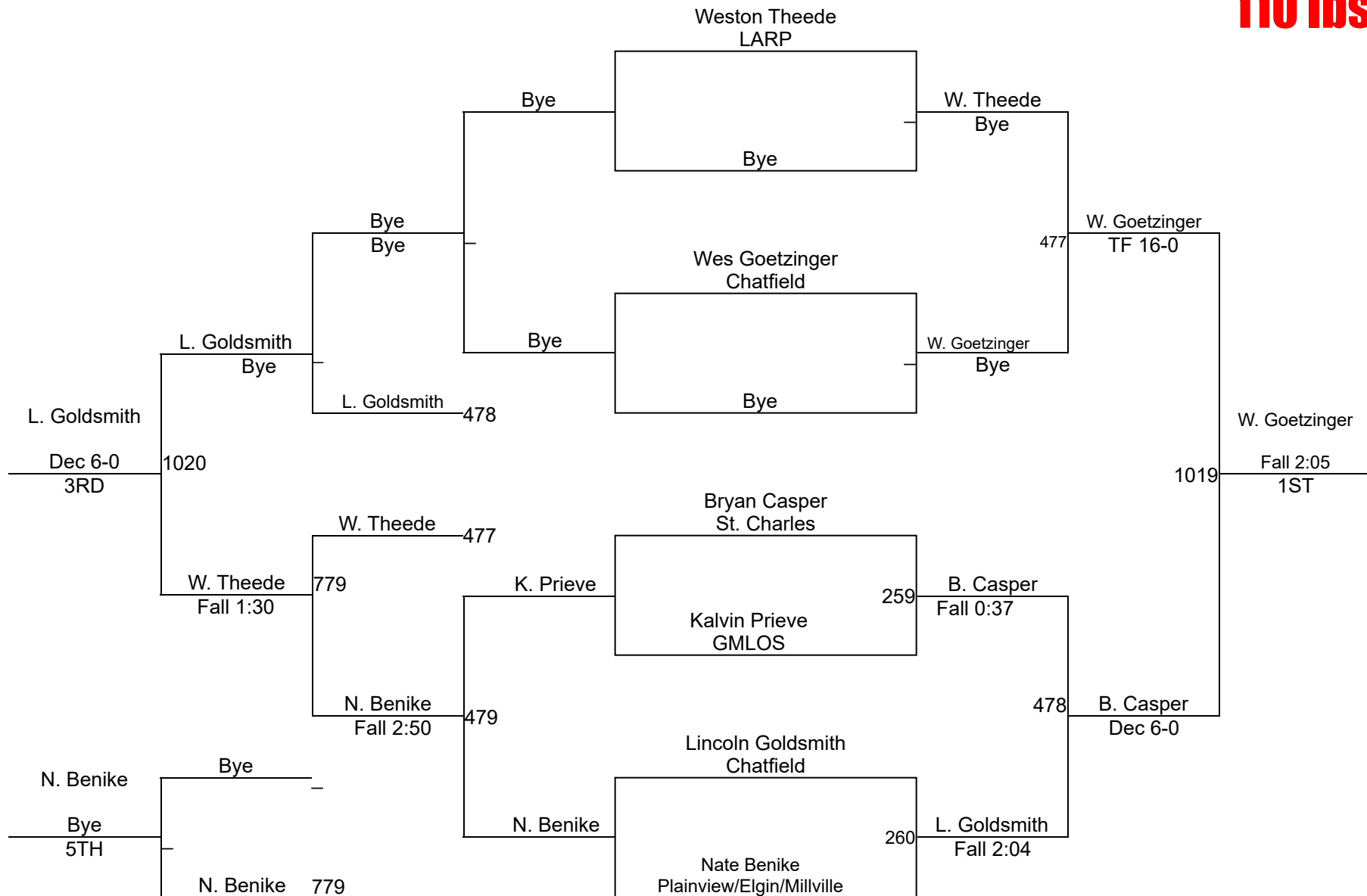

# NYWA Regional (Byron)

**7th & 8th**  
**115 lbs**

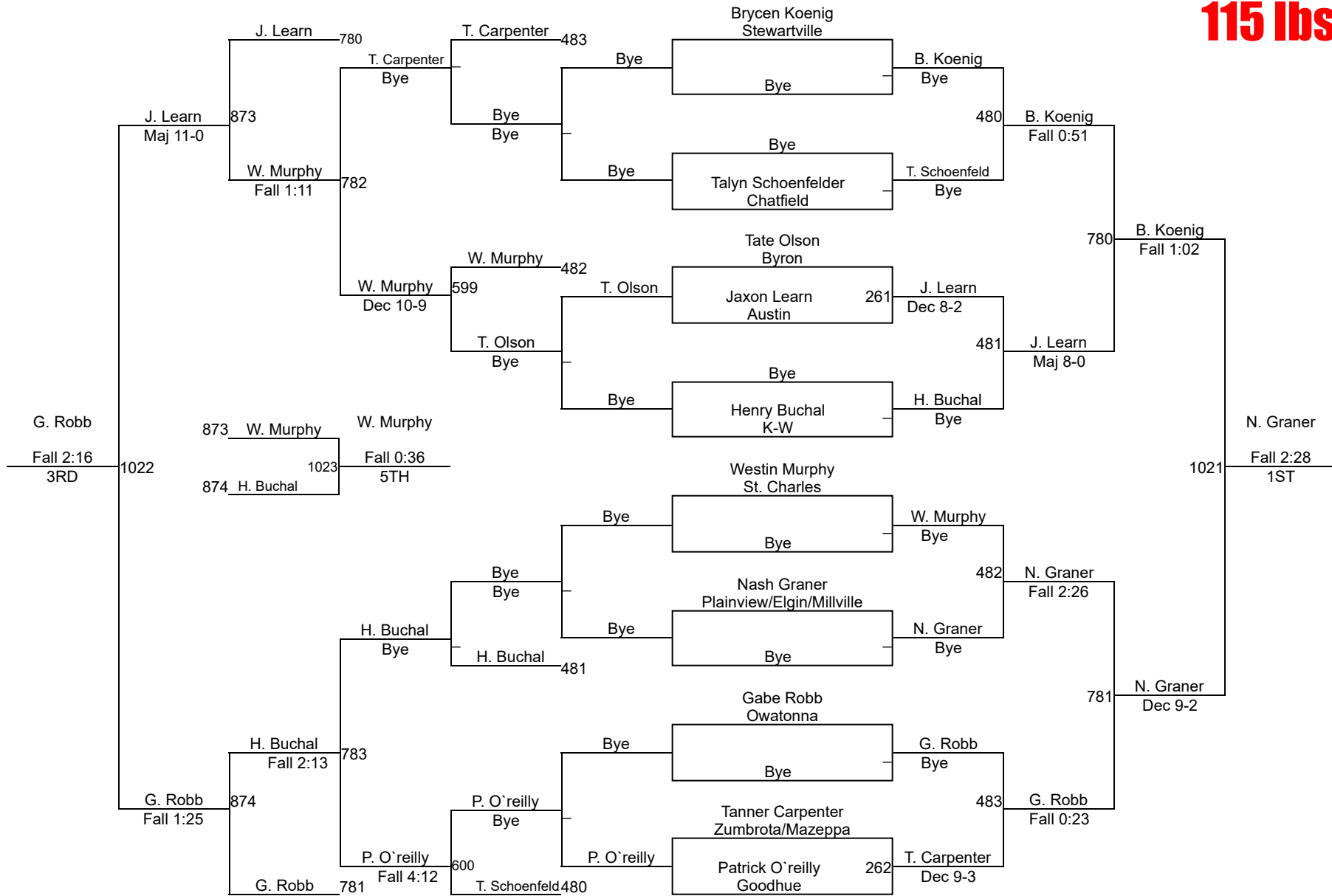

# NYWA Regional (Byron)

**7th & 8th  
120 lbs**

## Round 1

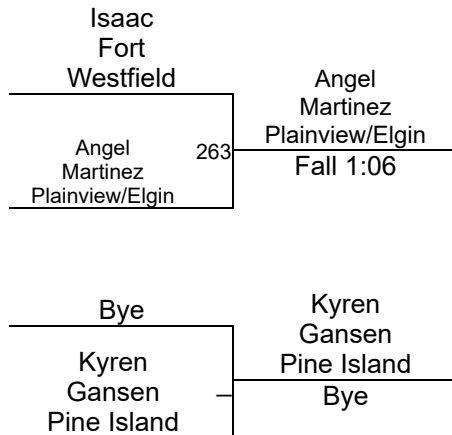

## Round 2

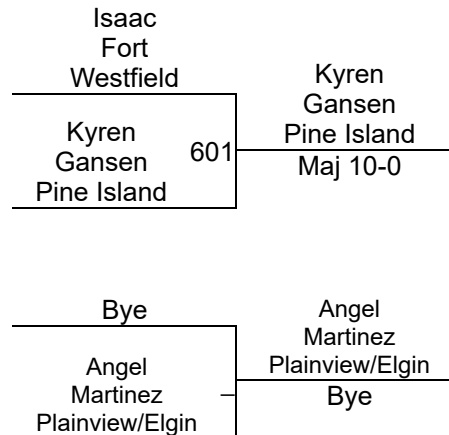

## Round 3

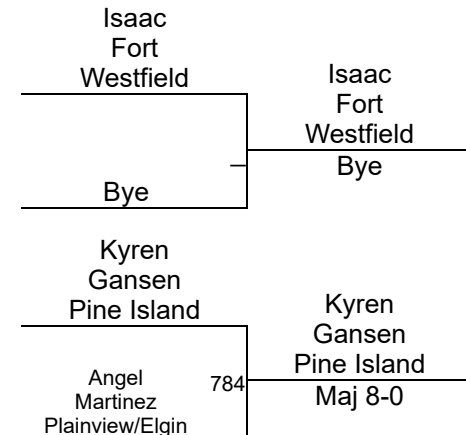

### WRESTLERS

I. Fort (Westfield)

A. Martinez (Plainview/Elgin/Milville)

Bye

K. Gansen (Pine Island)

K. Gansen (Pine Island)

**1ST**

A. Martinez (Plainview/Elgin/Milville)

**2ND**

I. Fort (Westfield)

**3RD**

Bye

**4TH**

# NYWA Regional (Byron)

**7th & 8th  
125 lbs**

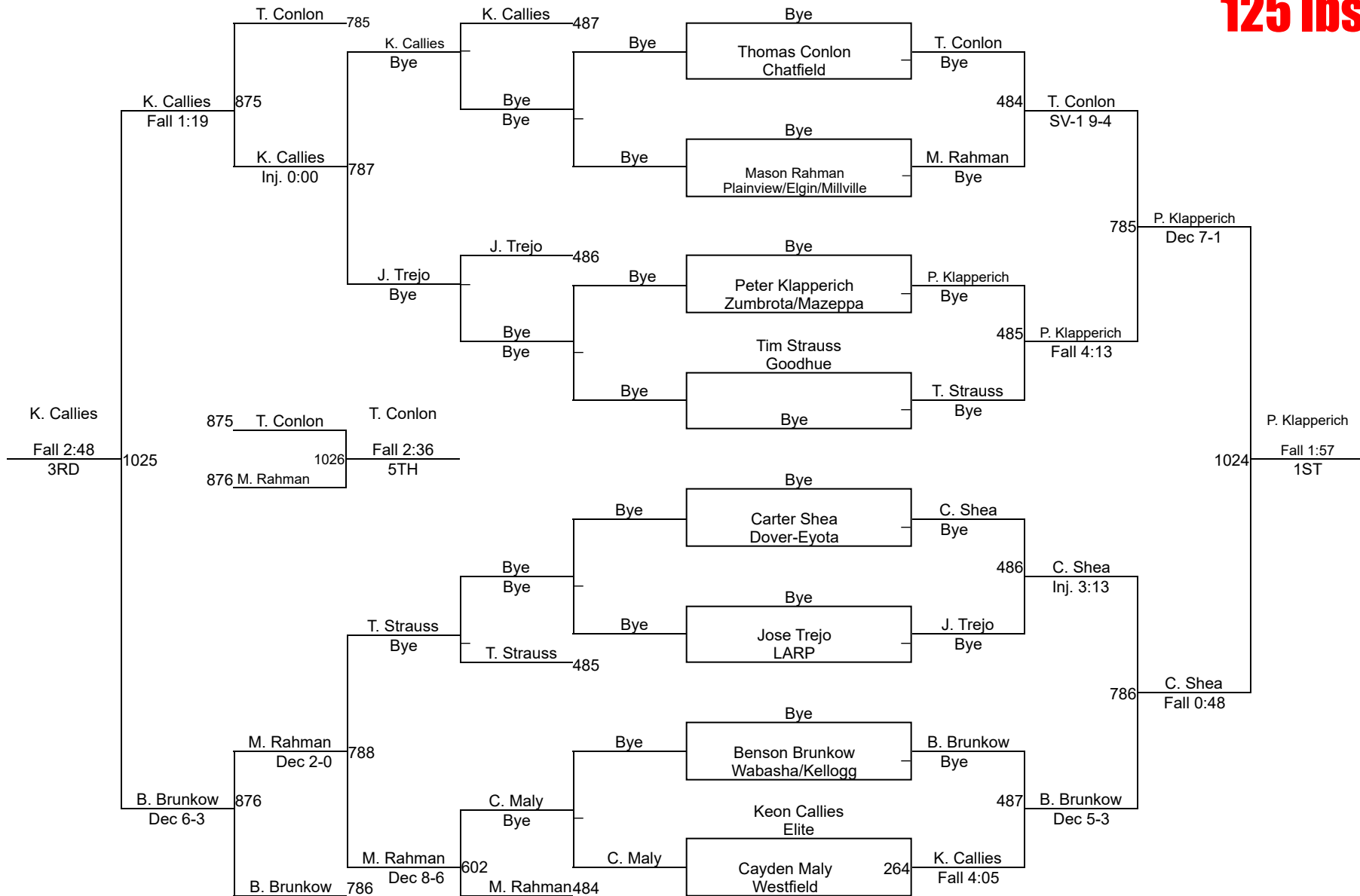



# NYWA Regional (Byron)

## 7th & 8th 130

C. Johnson		C. Johnson
I. Halbakken	286	Fall 2:59

C. Johnson		C. Johnson
O. Hass	512	Fall 3:28

C. Johnson		C. Johnson
Bye		Bye

C. Johnson		C. Johnson
N. Cocker	833	Fall 1:00

C. Johnson		N. Happel
N. Happel	913	Fall 2:38

### Round 1

N. Happel		N. Happel
N. Cocker	287	Fall 2:11

### Round 2

N. Happel		N. Happel
Bye		Bye

### Round 3

N. Happel		N. Happel
I. Halbakken	620	TF 15-0

### Round 4

N. Happel		N. Happel
O. Hass	834	Fall 0:29

### Round 5

N. Cocker		N. Cocker
Bye		Bye

Bye		O. Hass
O. Hass		Bye

N. Cocker		I. Halbakken
I. Halbakken	513	Maj 8-0

N. Cocker		O. Hass
O. Hass	621	Dec 7-3

Bye		I. Halbakken
I. Halbakken		Bye

O. Hass		I. Halbakken
I. Halbakken	914	SV-1 8-6

Nolan Happel (LARP)

**1ST**

Charlie Johnson (Northfield)

**2ND**

Isaac Halbakken (Dover-Eyota)

**3RD**

Orlando Hass (Plainview/Elgin/Millville)

**4TH**

Noah Cocker (K-M)

**5TH**

Bye

**6TH**

# NYWA Regional (Byron)

**7th & 8th**  
**135 lbs**

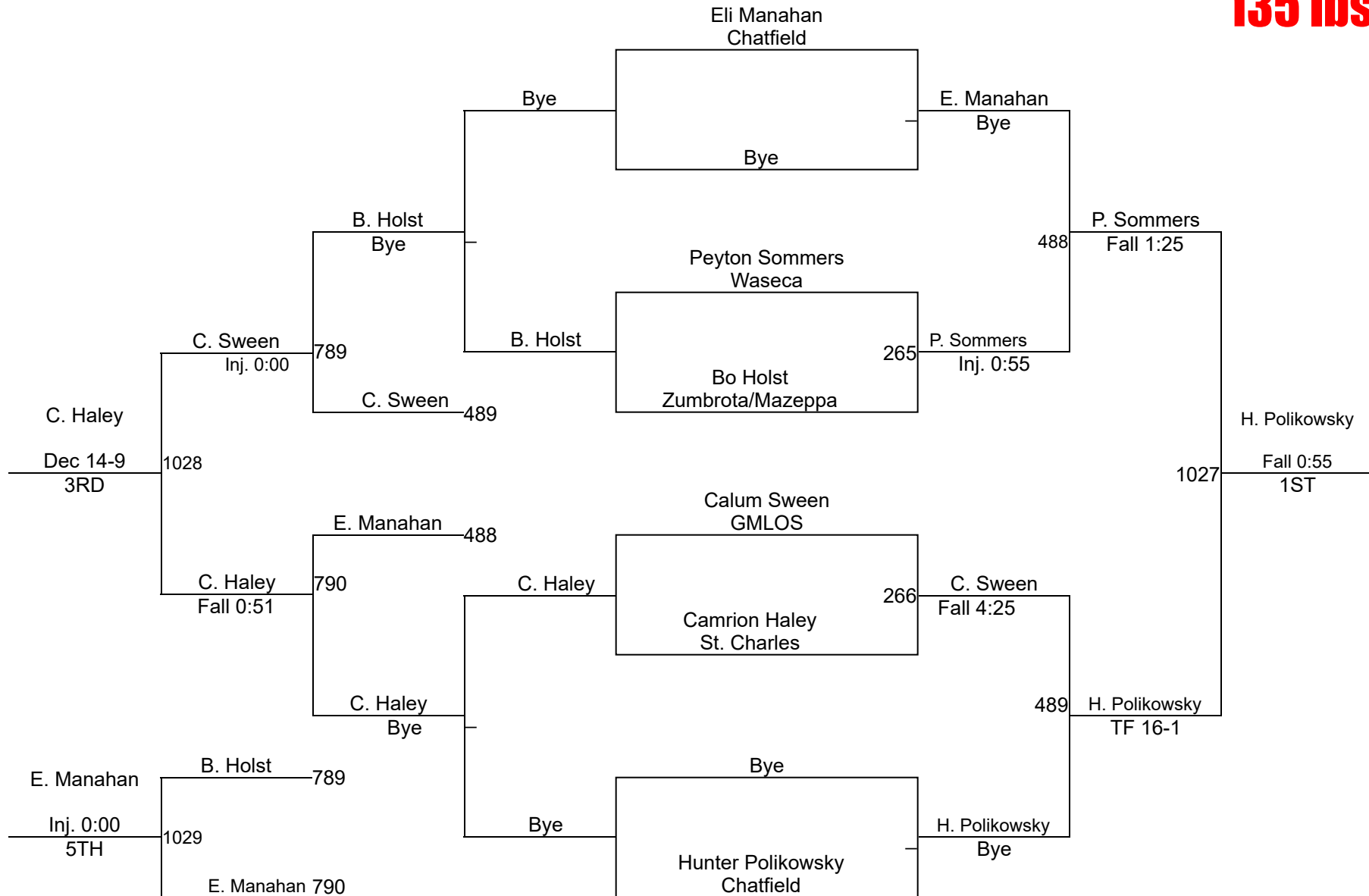

# NYWA Regional (Byron)

**7th & 8th**  
**140 lbs**

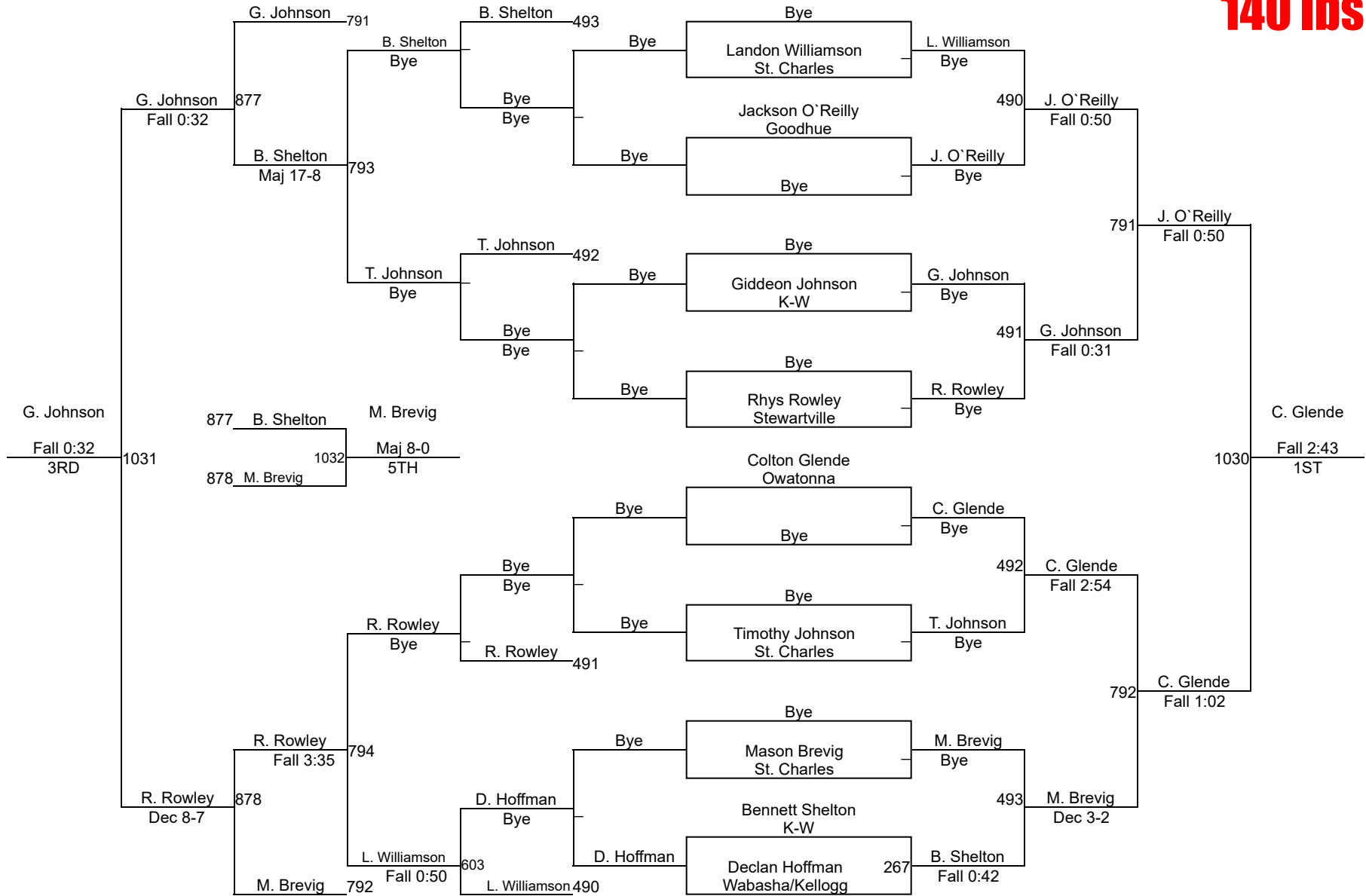

# NYWA Regional (Byron)

# 7th & 8th 150

S. Selthun	288	S. Selthun
G. O'Connor		Dec 5-0

S. Selthun	514	S. Selthun
B. Gaddis		Fall 3:58

S. Selthun	622	S. Harner
S. Harner		Fall 0:31

S. Selthun	835	S. Selthun
G. Edwards		Fall 2:45

S. Selthun		S. Selthun
Bye		Bye

## Round 1

Bye		G. Edwards
G. Edwards		Bye

## Round 2

Bye		S. Harner
S. Harner		Bye

## Round 3

Bye		G. O'Connor
G. O'Connor		Bye

## Round 4

Bye		B. Gaddis
B. Gaddis		Bye

## Round 5

G. Edwards	915	S. Harner
S. Harner		Fall 1:55

S. Harner	289	S. Harner
B. Gaddis		Fall 2:02

G. Edwards	515	G. O'Connor
G. O'Connor		Dec 7-5

G. Edwards	623	G. Edwards
B. Gaddis		Fall 1:24

S. Harner	836	S. Harner
G. O'Connor		Fall 2:23

B. Gaddis	916	G. O'Connor
G. O'Connor		Fall 3:48

Sam Harner (Northfield)

**1ST**

Samuel Selthun (Waseca)

**2ND**

Gabe O'Connor (Zumbrota/Mazeppa)

**3RD**

Gavin Edwards (Byron)

**4TH**

Bryce Gaddis (Byron)

**5TH**

Bye

**6TH**

# NYWA Regional (Byron)

**7th & 8th**  
**160 lbs**

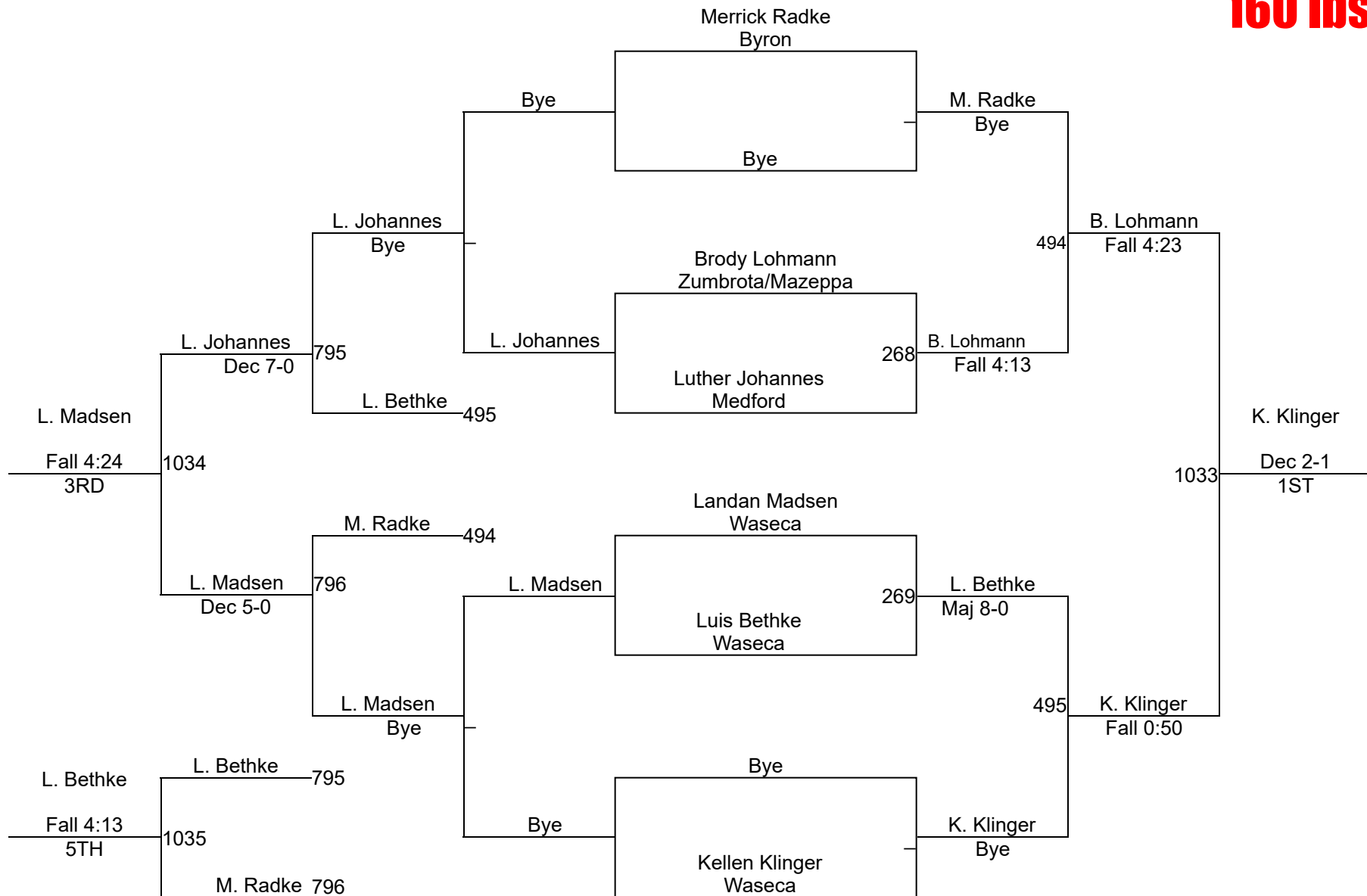

# NYWA Regional (Byron)

**7th & 8th**  
**235 lbs**

